

OPERATING MANUAL

ForceMaster 9110

©2013 burster
präzisionsmesstechnik gmbh & co kg
All rights reserved

Manufacturer:
burster präzisionsmesstechnik gmbh & co kg
Talstraße 1 – 5 P.O.Box 1432
76593 Gernsbach 76587 Gernsbach
Germany Germany

Valid from: 14.11.2013

Tel.: (+49) 07224 / 6450
Fax.: (+49) 07224 / 64588
E-Mail: info@burster.de
www.burster.de

Warranty - exclusion of liability

All information in the present documentation was prepared and compiled with great care and reproduced subject to effective control measures. No warranty is provided for freedom from errors. We reserve the right to make technical changes. The present information as well as the corresponding technical data can change without notice. Reproduction of any part of this documentation or its processing or revision using electronic systems is prohibited without the manufacturer's prior written approval.

Components, devices and measured value sensors made by burster präzisionsmesstechnik (hereinafter referred to as "product") are the results of targeted development and meticulous research. As of the date of delivery, burster provides a warranty for the proper condition and functioning of these products covering material and production defects for the period specified in the warranty document accompanying the product. However, burster excludes guarantee or warranty obligations, as well as any liability beyond that, for consequential damages caused by improper use of the product, in particular the implied warranty of success in the market as well as the suitability of the product for a particular purpose. Furthermore, burster assumes no liability for direct, indirect or incidental damages as well as consequential or other damages arising from the provision and use of the present documentation.



ForceMaster 9110



The measurement solution.

Konformitätserklärung (nach EN ISO/IEC 17050-1:2010) Declaration of conformity (in accordance with EN ISO/IEC 17050-1:2010)

Name des Ausstellers: burster präzisionsmesstechnik gmbh & co kg
Issuer's name:

Anschrift des Ausstellers: Talstr. 1-5
Issuer's address: 76593 Gernsbach, Germany

Gegenstand der Erklärung: ForceMaster 9110
Object of the declaration:

Modellnummer(n) (Typ): 9110
Model number / type:

Diese Erklärung beinhaltet obengenannte Produkte mit allen Optionen
This declaration covers all options of the above product(s)

Das oben beschriebene Produkt ist konform mit den Anforderungen der folgenden Dokumente:
The object of the declaration described above is in conformity with the requirements of the following documents:

Dokument-Nr <i>Documents No.</i>	Titel <i>Title</i>	Ausgabe/Ausgabedatum <i>Edition/Date of issue</i>
2006/95/EC	Niederspannungsrichtlinie <i>Low voltage directive</i>	2006
2004/108/EC	Elektromagnetische Verträglichkeit <i>Electromagnetic Compatibility</i>	2004
EN 61010-1	Sicherheitsbestimmungen für elektrische Mess-, Steuer-, Regel- und Laborgeräte <i>Safety requirements for electrical equipment for measurement, control an laboratory use.</i>	2010
EN 61326-1	Elektrische Mess-, Steuer-, Regel- und Laborgeräte - EMV-Anforderungen - Teil 1: Allgemeine Anforderungen – industrielle Umgebung <i>Electrical equipment for measurement, control and laboratory use. General requirements</i>	2006
EN 61000-3-2	Elektromagnetische Verträglichkeit – Teil 3-2: Grenzwerte für Oberschwingungsströme <i>Electromagnetic Compatibility – Limits for harmonic current emissions.</i>	2000
EN 61000-3-3	Elektromagnetische Verträglichkeit – Teil 3-3: Grenzwerte Spannungsänderungen, Spannungsschwankung und Flicker <i>Electromagnetic Compatibility – Limitation of voltage changes, voltage fluctuations and flicker.</i>	1995 +A1:2001

Gernsbach 29.04.2013 i.V. Christian Karius
Ort / place Datum / date Quality Manager

Dieses Dokument ist entsprechend EN ISO/IEC 17050-1:2010 Abs. 6.1g ohne Unterschrift gültig
According EN ISO/IEC 17050 this document is valid without a signature.

burster präzisionsmesstechnik gmbh & co kg · Talstr. 1-5 DE-76593 Gernsbach (P.O.Box 1432 DE-76587 Gernsbach) · Tel. +49-7224-6450 · Fax 645-88
www.burster.com · info@burster.com · burster is ISO 9001:2008 certified

Geschäftsführer/Managing Director: Matthias Burster · Handelsregister/Trade Register: Gernsbach · Registergericht/Register Court: Mannheim HRA 530170
Kmpl./Gen. Partn.: burster präzisionsmesstechnik Verwaltungs-GmbH · Handelsregister/Trade Register: Gernsbach · Registergericht/Register Court: Mannheim HRB 530130
UST-Identnr./VAT No. DE 144 005 098 · Steuernr./Tax Ident No. 39454/10503
Commerzbank AG Rastatt Kto./Acc. 06 307 073 00 BLZ/Bank code 662 800 53 · Volksbank Baden-Baden* Rastatt eG Kto./Acc. 302 082 00 BLZ/Bank code 662 900 00

Contents

1.	For your safety	9
2.	Introduction	10
2.1	Intended use	10
2.2	Ambient conditions	10
2.2.1	Storage conditions	10
2.2.2	Conditions of use	10
2.3	Personnel	11
2.4	Scope of supply	11
2.5	Conversions and modifications	11
3.	Device concept	12
3.1	Range of functions	12
3.2	Simple operation	12
3.3	Autoconfiguration	12
3.4	Counter	12
3.5	Documentation of measuring operations	12
3.6	Languages	13
3.7	Support for automation	13
3.8	Front view of the ForceMaster 9110	14
3.9	Rear view of the ForceMaster 9110	15
3.10	Menu structure of the ForceMaster 9110	16
3.10.1	Operating example (extract from the menu)	18
3.10.2	Aids to orientation for operation	18
3.10.3	Display and operating concept	19
3.10.4	Entering text and numbers	20
3.11	Autoconfiguration	21
3.11.1	"Autoconfig" menu	21
3.11.2	"Step 1: teach-in"	22
3.11.3	"Step 2: Set Modes"	22
3.11.4	"Step 3: Set values"	24
3.11.5	Finish autoconfiguration	26
3.12	Card reader	27
3.12.1	MasterCard	27
3.12.2	ToolCard	27
3.12.3	PLCCard	27
3.13	"PLC & IO" menu	28
3.13.1	List of possible conditions	31

ForceMaster 9110

3.13.2	List of possible commands	32
3.14	"Cam" menu	32
3.15	Measuring and adjusting	34
3.16	Force alarms.....	34
3.16.1	Force alarm 1.....	34
3.16.2	Force alarm 2.....	34
3.17	Step chain controller (option)	35
3.18	Cam switching mechanism.....	36
3.19	I/O interface	37
3.19.1	Connector pin assignments	37
3.19.2	I/O signal combinations	38
3.20	Switching on procedure.....	39
4.	Initial commissioning	40
4.1	Fitting the load cell to the manual press.....	40
4.2	Fitting the displacement measurement system (DMS) to the manual press	41
4.3	Setting up the measurement chain on the ForceMaster 9110	43
5.	Measurement.....	45
6.	Configuring the ForceMaster 9110 settings	48
6.1	"Counter" menu	49
6.2	USB stick (option).....	51
6.2.1	Operation with a USB stick.....	51
6.2.2	"USB stick" menu.....	52
6.2.3	Data storage example.....	56
6.3	"PLC & IO" menu.....	57
6.3.1	List of possible conditions.....	60
6.3.2	List of possible commands	61
6.4	"Cam" menu	61
6.5	"CARD" menu.....	63
6.6	"Manual settings" menu.....	66
6.7	"Error signals" menu.....	68
6.8	"Order data" menu.....	71
6.9	"Statistics" menu.....	73
6.10	"Manual and internal settings" menu.....	74
6.11	"Date & time" menu	79
6.12	"Status" menu.....	80
6.13	"Languages" menu	80

7. Force-displacement curves	81
8. Technical data	88
9. Configuration notes	89
9.1 Choosing the right load cell	89
9.2 Choosing the right displacement sensor	90
9.3 Advice	90
10. Available accessories	91
11. Ordering example	92
12. Index	93

ForceMaster 9110

1. For your safety

The following symbols on the device and in this manual warn of hazards:

Symbols in the manual



Warning

Death or serious injury **can** occur if no appropriate precautions are taken.



Caution

Damage to property can occur if no appropriate precautions are taken.

Note

It is important to heed these safety notices in order to ensure correct handling of the instrument.

Symbols on the device



Observe the text on the device

Observe the text next to/underneath the warning sign:

"Unplug the mains before opening! - Observe safety instruction - Servicing only by trained technicians"

2. Introduction

2.1 Intended use

The ForceMaster 9110 is a device for monitoring repetitive production processes. Its particular purpose is the recording and evaluation of process signals, where the curve of the force has a defined relationship with displacement or time. The result of the analysis is classified as either ACCEPTABLE (OK) or is NOT acceptable (NOK). Visual and acoustic signals are given, and made available at various interfaces.

The device is not a replacement for safety equipment, such as for the emergency shutdown of a press if the pressing force exceeds a limit value.

2.2 Ambient conditions

2.2.1 Storage conditions

- clean packaging
- dry
- no condensation
- temperature between 0 °C and +60 °C

2.2.2 Conditions of use

- indoors
- maximum altitude: 2000 m above sea level
- operating temperature: between +5 °C and +40 °C
- humidity: 80% up to 31 °C, decreasing linearly above that temperature to 50% at T_{\max} , no condensation
- protection class:1
- transient excess voltage: according to Category 2
- potential to ground: ≤ 12 V DC between analog ground and ground
- supply voltage: 90 to 264 V_{eff} , 47 to 63 Hz

2.3 Personnel

The operating personnel must be familiar with the respectively applicable regulations. They must follow these regulations.

2.4 Scope of supply

- ForceMaster 9110
- Operating manual
- 1 x mains cable
- PC software
- MasterCard 9110-Z001

2.5 Conversions and modifications

If you open up the ForceMaster 9110 or dismantle it during the warranty period, the warranty will be **immediately** voided.

The ForceMaster 9110 may only be opened by our technical personnel.

It is forbidden to make any modification to the ForceMaster 9110 without our written permission. In that case we can accept no liability.

3. Device concept

3.1 Range of functions

The ForceMaster 9110 is a measuring instrument that monitors production operations at manual presses by measuring the applied force and the distance travelled by the punch.

The design includes mechanisms that make sure that reported errors cannot be ignored.

3.2 Simple operation

Bei der Entwicklung des ForceMaster 9110 wurde auf einfache Bedienung großer Wert gelegt. Es gibt nur einen Bedienknopf, der genügt, um durch das Menü zu navigieren.

3.3 Autoconfiguration

The work required to set up the ForceMaster 9110 has been simplified through the introduction of an autoconfiguration system. You carry out the pressing of a part as an example, and the ForceMaster 9110 records the pressing forces and the distance.

This makes all settings automatically. Whether the sensors are of F or F/s type is also detected. The measuring mode is set automatically. Units such as newtons (N), kilonewtons (kN) or displacement (mm) are set automatically.

3.4 Counter

The ForceMaster 9110 counts the number of parts that have been checked, recording both the total number of parts as well as how many were assessed as OK and how many were NOK (not OK). In practice, the number of parts that are assessed as NOK must be the same as the number of parts in the scrap box at the manufacturing station. In this way you can also check whether the worker has correctly sorted out the scrap parts.

3.5 Documentation of measuring operations

The ForceMaster 9110 offers several options for documenting production quality. You are also able to write up to 50 manufacturing jobs into a job memory, transfer this to an Excel table, and store it on a USB stick.

It must be possible to trace the documentation back to the individual manufacturer part. This is only possible if a large amount of memory is available and if the data can be handled easily. These facilities are provided by a USB stick.

Two recording modes are available to you. A CSV file is generated in both cases. Many statistical programs (e.g. Excel, Access) can process this format.

- A job file records the data measured for each part, including what force was reached, and whether the part was OK.
- A menu allows you to choose whether the entire pressing curve is to be stored. Because a pressing curve contains a relatively large amount of data, the storage process takes up to 3 seconds. In addition, this data record takes a correspondingly large amount of storage on the stick.

It is possible to collect the accumulated data daily, and to use another stick for the following day. The data that has been collected can then be saved on a PC or a server.

The large amount of storage available on a USB stick makes it possible to store the documentation over a longer period of time. You should, however, evaluate the data regularly, so that anything learnt from it can promptly be used to modify the production process.

3.6 Languages

The ForceMaster 9110 can be set for operation in a number of languages. See Section 6.15 for the available languages.

3.7 Support for automation

The ForceMaster 9110 has a simple, freely programmable step chain controller, is supported in addition by a cam switching mechanism. This allows simple, small-scale automation to be implemented. There are 6 cams. Control signals can be triggered by these cams. Each cam can be programmed in a variety of ways. The cam signals can exclusively be used through the optional step chain controller.

ForceMaster 9110

3.8 Front view of the ForceMaster 9110



Key	Explanation
1	Card reader
2	Two-line display
3	Folding feet
4	Operating knob
5	Red indicator lamp NOK
6	Green indicator lamp OK
7	Loudspeaker

3.9 Rear view of the ForceMaster 9110

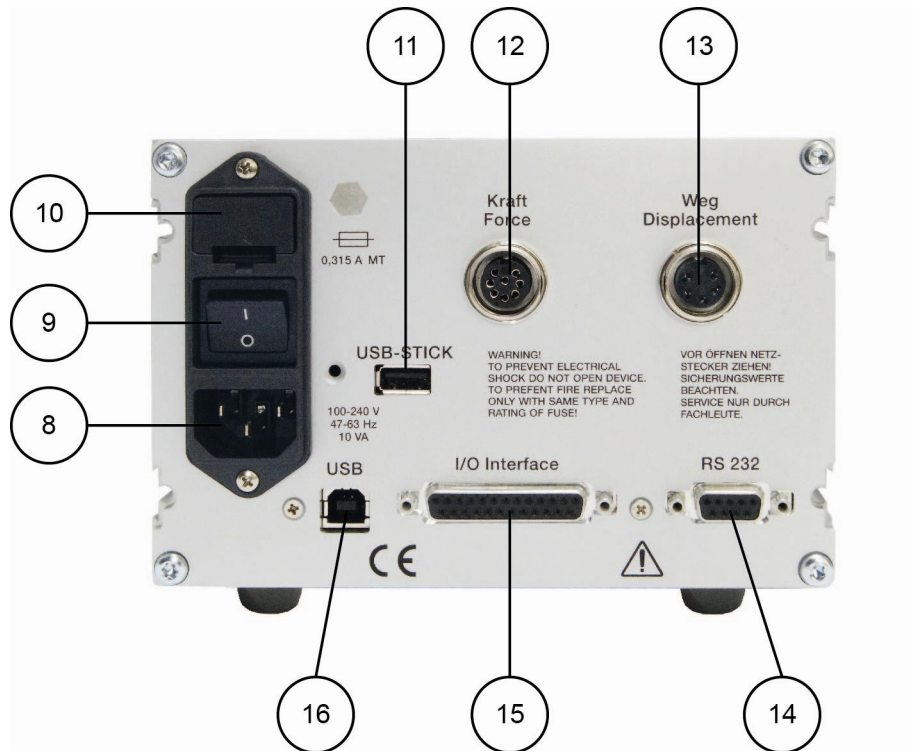

Key	Explanation
8	Mains connection
9	Mains switch
10	Fuse
11	Connection for USB stick (optional)
12	Connection for load cell
13	Connection for displacement sensor
14	RS232 interface
15	I/O interface
16	USB connection for PC

ForceMaster 9110

3.10 Menu structure of the ForceMaster 9110

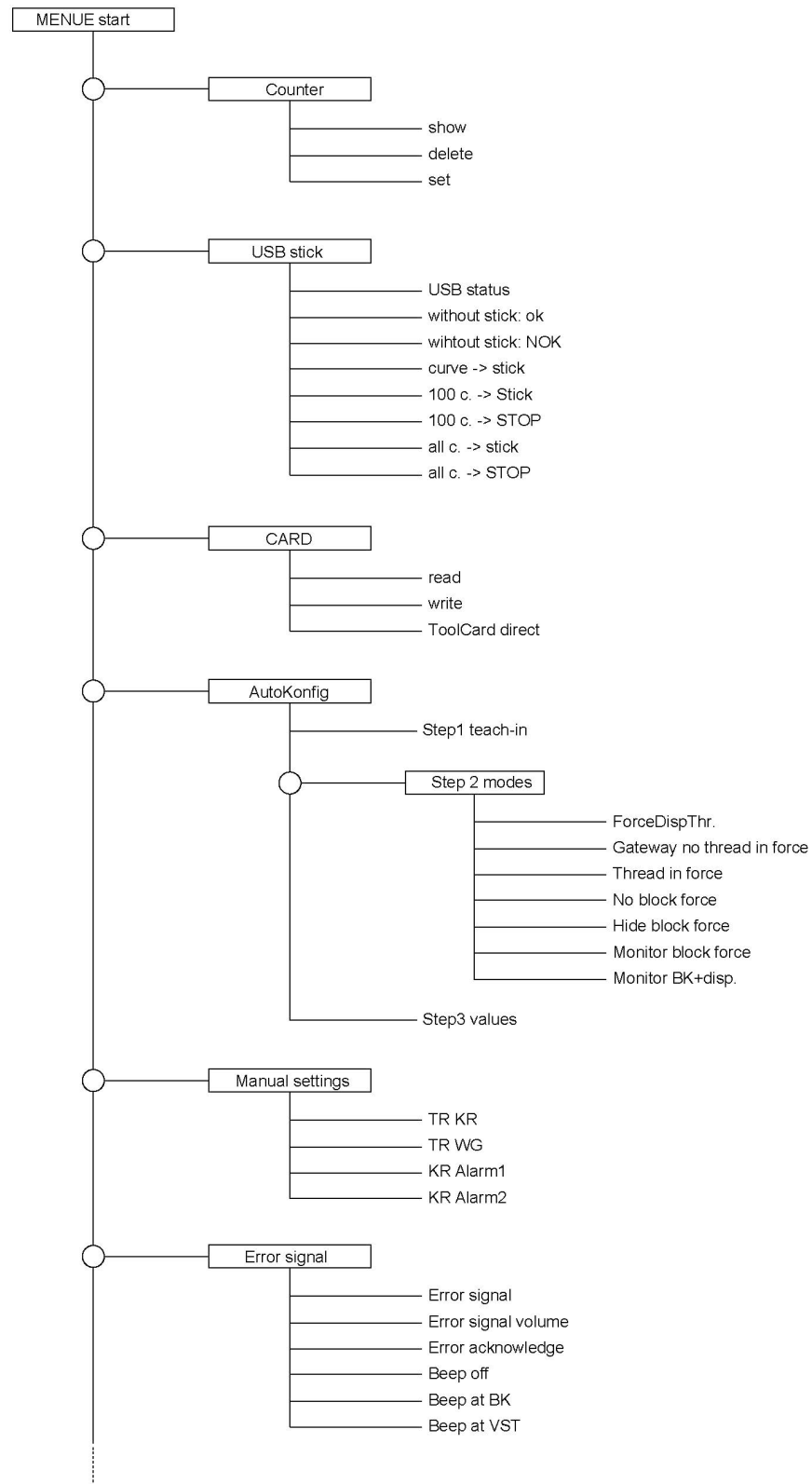

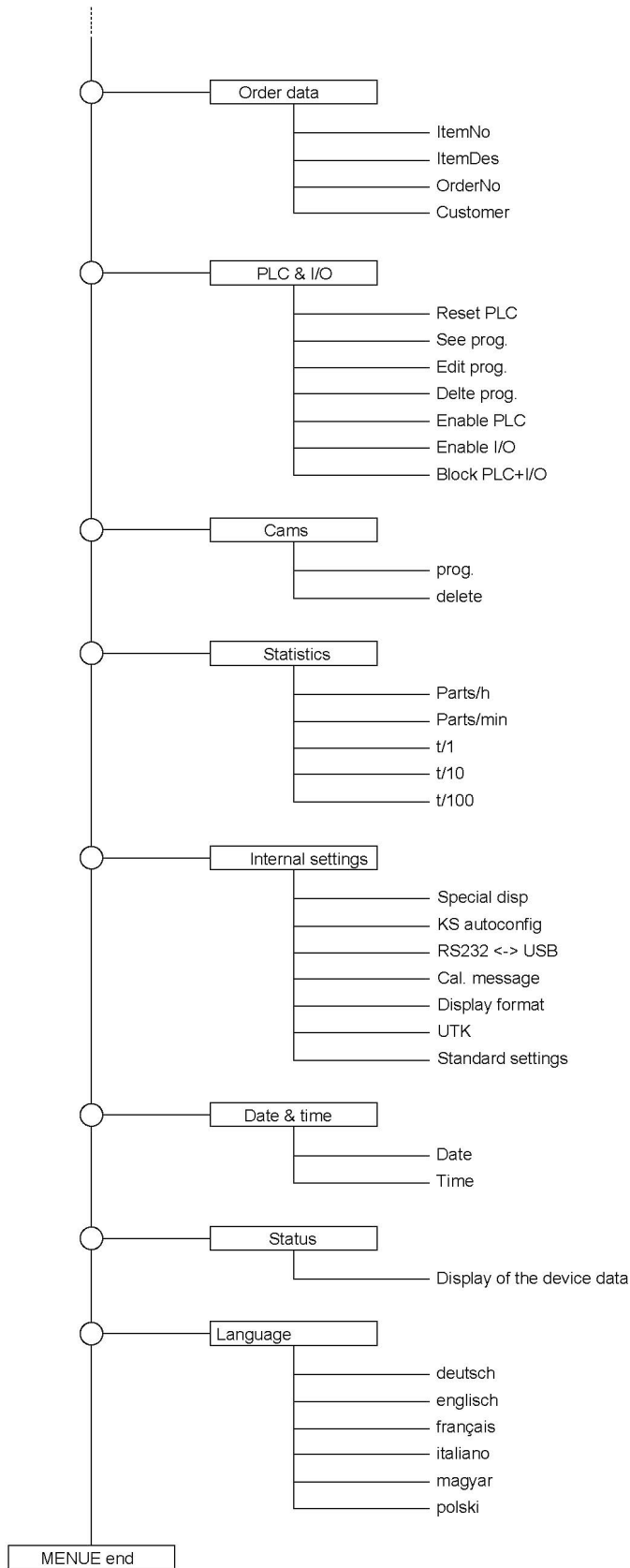

ForceMaster 9110

3.10.1 Operating example (extract from the menu)

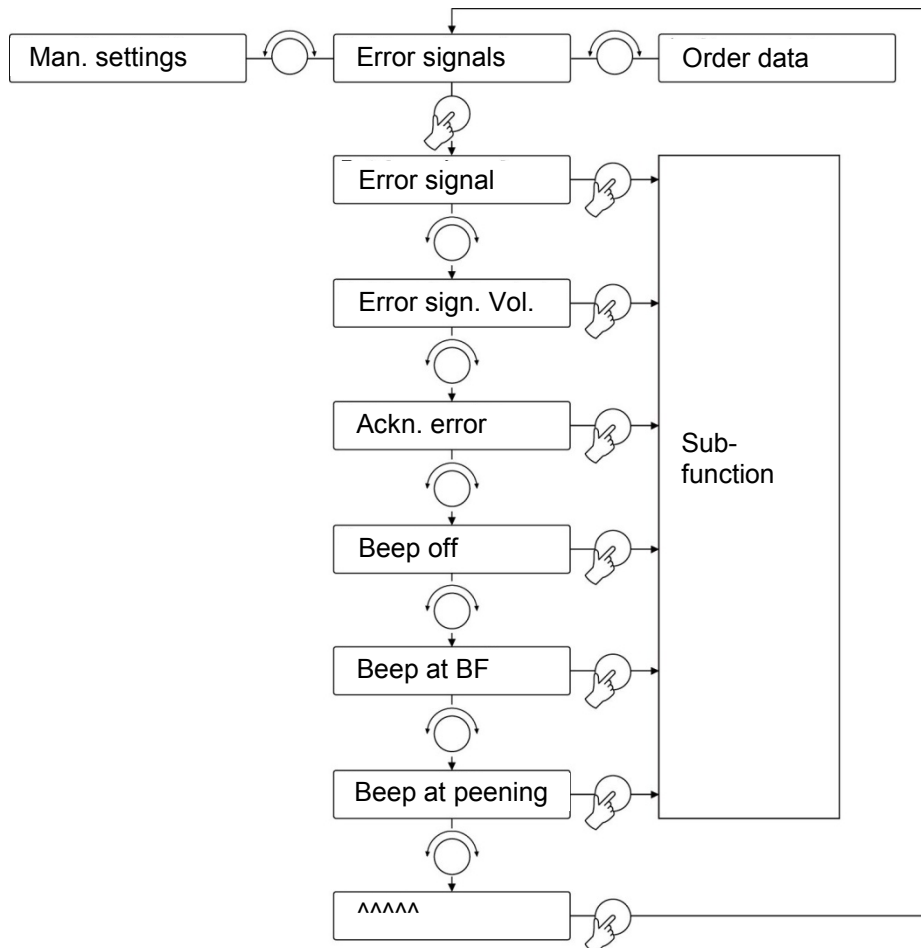

Extract from the setting menu

The menu structure of the ForceMaster 9110 has been kept simple.

Like PC applications, there is a main menu. When you select a menu item, you are taken to a sub-menu.

3.10.2 Aids to orientation for operation

Arrows that indicate the possible directions of rotation are provided on the lower right of the display, immediately next to the rotary knob, for better orientation in the menu.

If the arrow points to the left (<) or to the right (>) you can turn the operating knob to the left or right in order to reach a menu item.

Note

There are menu functions that can be switched on or off.

An asterisk (*) appears at the end of the line if the function is switched on, so that you can see the status straightaway.



3.10.3 Display and operating concept

A single knob, which you can turn and press, serves as the operating element.

When you have found the menu item where you want to change something, press the operating knob. This takes you to a sub-menu. By turning the operating knob, you can navigate through the sub-menu. When you have found the function you want, press the knob in order to select it.



This is how it works

- 1 Turn the operating knob until the menu item you want appears on the display.
- 2 Press the operating knob in order to select the menu item.

To return from a sub-menu back to the main menu, turn the operating knob to the last menu item, represented by arrows (^^^^), and select it.



This is how it works

- 1 Turn the operating knob until the row of arrows (^^^^) appears on the display.
- 2 Press the operating knob to go to the main menu.

3.10.4 Entering text and numbers

Text and numbers are input in order to make the settings in some of the menu items.

- 1 Turn the operating knob to move the cursor to the location in the text that you want to change.

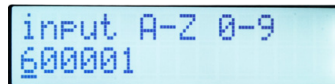

- 2 Press the knob in order to select the text location.
- 3 Turn the operating knob in order to select the letter or the number that you want.
- 4 Press the button again in order to confirm the selection.
- 5 Repeat steps 1 - 4 for every location in the text that you would like to change.
- 6 In order to end the text input, move the cursor past the last location on the line.

"input END?" then appears on the display.

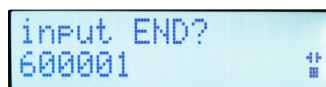

- 7 Confirm that you are ending the input by pressing the operating knob.
- 8 When the pressing operation is complete, the numeric display shows "Step 2 set modes".

3.11 Autoconfiguration

Autoconfiguration allows two aspects of the ForceMaster 9110 to be dealt with quickly and easily. The ForceMaster 9110 detects the sensors that have been connected, and a teaching process takes place in order to find the optimum monitoring values for the parts to be checked.

- Always start setting up the ForceMaster 9110 with an autoconfiguration.

If you want to correct the monitoring values manually at a later stage, you must first carry out an autoconfiguration.

When you start the autoconfiguration, the ForceMaster 9110 will offer you the most reasonable monitoring mode, according to whatever sensors you have connected.

The autoconfiguration brings you to an automated result in three steps. These three steps are:

Step 1: Teaching

The connected sensors and their attachment are detected automatically, and the teaching process is initiated. Process a workpiece. Based on this process, the ForceMaster 9110 analyses the force-displacement profile and offers a setting for the monitoring modes and monitoring parameters.

Step 2: Setting the modes

You can check which monitoring modes the ForceMaster 9110 suggests, and are able to specify a different one.

Step 3: Setting the parameters

You can check what monitoring parameters have been found by the ForceMaster 9110 for the individual monitoring regions, and have the option of correcting them.

You then change to the measuring mode. You are also able to return to Step 1, and to run through the autoconfiguration again with other parts.

3.11.1 "Autoconfig" menu

This menu offers you a way to get into the autoconfiguration.

Autoconfig	
Step 1 teach-in	Choose this menu item to start a teaching process. This is the usual starting point for a part that is to be trained for the first time.
Step 2 Modes	Choose this menu item to correct the modes.
Step 3 Values	Choose this menu item to correct the values.

For a new part, start with "teach-in", and you will then be taken through all the following points.

For corrections (without a new teaching session), either choose "Step 2" to correct the modes, or choose "Step 3" to correct the monitoring values.

If you have changed the values so much that it's no longer possible to take reasonable measurements, then start a new autoconfiguration with "Teaching" in order to get to sensible values again.



This is how it works

3.11.2 "Step 1: teach-in"

Always start the settings for a new part with a Teaching.

- 1 Open the "Autoconfiguration" menu.
- 2 Press the operating knob in order to select "Step 1 teach-in".
The display now shows: "waiting: downwards".
- 3 Carry out a pressing operation.
After you have pressed a part, but before you move the punch upwards again, the display shows "waiting: upwards".
- 4 Move the punch back up.
When the pressing operation is complete, the display shows "Step 2 Set modes".
It may be necessary to correct the values learnt through the autoconfiguration. If necessary, they can be adjusted manually.

3.11.3 "Step 2: Set Modes"

In this step you can set the modes that are possible for monitoring. Selected modes are indicated by a star.

In the pressing region you choose between force-displacement thresholds and five force gateways. You can switch monitoring of the thread in force on or off.

Step 2 Set modes	
Force-displacement thresholds	Means that force-displacement thresholds are monitored.
Gateways	Means that gateways specified in the force profile are monitored.
No thread in force	Means that there is no thread in force.
Thread in force	Means that there is an thread in force.
No blocking force	Means that no monitoring takes place in the blocking force region.
Hide blocking force	Means that the curve must stop between the start and end of blocking. There is no force monitoring in this region.
Monitor blocking force	Means that between the start and end of blocking the curve must reach the lower blocking force threshold. The upper blocking force threshold must not be exceeded here.
Monitor the blocking force + peening displacement	Means that the blocking force and the peening displacement are monitored.

If only forces monitored, only one mode is available:

Step 2 Set modes	
Force thresholds	Means that force thresholds are monitored

Setting the modes

- 1 Open the "Set modes" sub-menu.
- 2 Select the mode that you want to set.
- 3 Press the operating knob to confirm the setting.

ForceMaster 9110

3.11.4 "Step 3: Set values"

Set level		
Displacement low		These values are to be set if you chose the "Force-displacement thresholds" item in Step 2. "Displacement low" is the beginning of the pressing phase.
Displacement high		The end of the pressing phase.
Force low		The force threshold, that the pressing force must at least reach.
Force high		The force threshold that the pressing force must not exceed.
Set gateways		
T1 lo		These values are to be set if you chose the "Gateways" item in Step 2. "lo" is the lower force value of the gateway.
T1 hi		The upper force value of the gateway.
T1 WG		The displacement value at which the gateways evaluated.
T2 lo		You can specify up to five gateways.
...		
Set blocking		
Displacement low		These values are to be set if you chose the "Monitor blocking force" item in Step 2. "Displacement low" is the beginning of the blocking force monitoring.
Displacement high		The end of the blocking force monitoring.
Force low		The force threshold that the blocking force must at least reach. (Omitted in the "Hide blocking force" mode)
Force high		The force threshold that the blocking force must not exceed. (Omitted in the "Hide blocking force" mode)
Set the peening displacement		
Pdisp min		These values are to be set if you chose the "Monitor blocking force + Pdisp" item in Step 2. "Pdisp min" is the peening displacement that must be reached as a minimum.
Pdisp max		The peening displacement that must not be exceeded.

Set thread in force	
Fldisp high	These values are to be set if you chose the "Thread in force" item in Step 2. "Fldisp" high is the final position, up to which the thread in force is monitored.
Fforce high	The threshold that the thread in force must not exceed.

The following limit values can be set when only force is monitored:

Set level	
Force low	The force threshold, that the pressing force must at least reach.
Force high	The force threshold that the pressing force must not exceed.

Set the values for the force thresholds (pure force monitoring) or force-displacement thresholds

- 1 Open the "Set values" menu.
- 2 Press the operating knob in order to select the "Set level" menu item.
- 3 Select the value that you want to set.
- 4 Turn the operating knob in order to set the value.
- 5 Press the operating knob to confirm the setting.

Set the values of the gateways

- 1 Open the "Set values" menu.
- 2 Turn the operating knob until the "Set gateways" menu item appears.
- 3 Press the operating knob in order to select the menu item.
- 4 Select the value that you want to set.
- 5 Turn the operating knob in order to set the value.
- 6 Press the operating knob to confirm the setting.

Set the values of the blocking force monitoring

- 1 Open the "Set values" menu.
- 2 Turn the operating knob until the "Set blocking" menu item appears.
- 3 Press the operating knob in order to select the menu item.
- 4 Select the value that you want to set.
- 5 Turn the operating knob in order to set the value.
- 6 Press the operating knob to confirm the setting.

Set the values for the peening displacement

- 1 Open the "Set values" menu.
- 2 Turn the operating knob until the "Set peening displacement" menu item appears.
- 3 Press the operating knob in order to select the menu item.
- 4 Select the value that you want to set.
- 5 Turn the operating knob in order to set the value.
- 6 Press the operating knob to confirm the setting.

Set the values of the thread in force monitoring

- 1 Open the "Set values" menu.
- 2 Turn the operating knob until the "Set thread in force menu item appears.
- 3 Press the operating knob in order to select the menu item.
- 4 Select the value that you want to set.
- 5 Turn the operating knob in order to set the value.
- 6 Press the operating knob to confirm the setting.

3.11.5 Finish autoconfiguration

Autoconfiguration has been completed.

You can now change to measuring operation.

Select "MENU" in order to make more settings at the device. This will take you back to the settings menu.

3.12 Card reader

A memory card can be inserted into the ForceMaster 9110. The card must always be inserted with the contact to the right of the display.

There are three different memory cards, known as the MasterCard, ToolCard and PLCCard.

If you want to write data to a card, the ForceMaster 9110 checks whether it is the correct card. You cannot, for example, store tool data to a MasterCard. In that case, an error message would appear on the display.

3.12.1 MasterCard

If a MasterCard is inserted in measuring mode, and the operating knob is turned to the right, you open the settings menu.

The MasterCard allows you to make certain settings at the device. This is not possible without the MasterCard.

This prevents unauthorized users from changing important settings.

3.12.2 ToolCard

You can save the settings of the ForceMaster 9110 for a particular part that you make on the ToolCard, and save them for later jobs.

If the part concerned has to be produced on another occasion, insert the associated ToolCard into the ForceMaster 9110 and read the card in. The data saved on this card is then used for the settings.

The following settings are saved:

- Order number
- Order name
- Part number
- Customer
- Down counter text
- Down counter value
- Set measuring mode
- Set PLC mode
- Set operating configuration
- All the force and displacement values for monitoring the measurement
- Alarm thresholds

3.12.3 PLCCard

The description above for the ToolCard also applies to the PLCCard. There is more detail in Section 6.3.

ForceMaster 9110

3.13 "PLC & IO" menu

This menu is only present on the ForceMaster 9110 with the step chain option. The step chain is a very good way of automating small workstations economically.

See Section 3.17 "Step chain controller (option)" for more information.

You can make the following selections in the sub-menus:

Reset PLC		
		This sub-menu item resets the PLC.
See program		
		This sub-menu item allows you to see the PLC program, but not to change it. This lets you get a quick overview of the program. By turning the knob, you can navigate through the lines. Press the operating knob to return to the main menu.
Edit program		
	Next STEP	Select this sub-menu item in order to edit the next program step.
	Entry condition	Select this sub-menu item in order to specify the condition for the program step. You will find a list of possible conditions in Section 6.3.1 List of possible conditions.
	Entry command	Select this sub-menu item in order to specify the command in the program step. You will find a list of possible commands in Section 6.3.2 List of possible commands.
	Entry parameter	Select this sub-menu item in order to specify the parameter for the program step.
	Entry END	Select this sub-menu item in order to stop processing the program step.
	Previous STEP	Select this sub-menu item in order to edit the previous program step.
Delete program		
		Select this sub-menu item in order to delete the program entirely.
Enable PLC		
		You can enable the PLC in this sub-menu. The PLC executes the program.
Enable I/O		
		The standard error message signals are provided at the outputs through this menu item.
Blog PLC + I/O		
		Activate this menu item in order to stop receiving signals at the outputs.



This is how it works

Reset PLC

- 1 Open the "PLC & I/O" menu.
- 2 Press the operating knob in order to select the "Reset PLC" menu item.

See program

- 1 Open the "PLC & I/O" menu.
- 2 Turn the operating knob until the "See program" menu item appears.
- 3 Press the operating knob in order to select the menu item.
- 4 Turn the operating knob in order to navigate through the lines of the menu.
- 5 Press the operating knob to return to the main menu.

Edit program

- 1 Open the "PLC & I/O" menu.
- 2 Turn the operating knob until the "Edit program" menu item appears.
- 3 Press the operating knob in order to select the menu item.
- 4 Turn the operating knob until the "Entry condition" menu item appears.
- 5 Press the operating knob in order to select the menu item.
- 6 Turn the operating knob in order to select the condition that you want.
- 7 Press the operating knob to confirm the condition.
- 8 Press the operating knob in order to select the "Entry command" menu item.
- 9 Turn the operating knob in order to select the command that you want.
- 10 Press the operating knob to confirm the command.
- 11 Press the operating knob in order to select the "Entry parameter" menu item.
- 12 Turn the operating knob in order to set the parameter that you want.
- 13 Press the operating knob in order to select the "Next STEP" menu item.
- 14 Repeat steps 2 to 13 until you have written the program through to the end.
- 15 If you want to correct an earlier step, turn the operating knob until "Previous STEP" appears. Press the operating knob. Repeat this procedure until the step that needs correcting appears.
- 16 Turn the operating knob until the "END entry" menu item appears.
- 17 Press the operating knob in order to select the menu item.

Delete program

- 1 Open the "PLC & I/O" menu.
- 2 Turn the operating knob until the "Delete program" menu item appears.
- 3 Press the operating knob in order to select the menu item.
- 4 Turn the operating knob until the "Yes" menu item appears.
- 5 Press the operating knob in order to select the menu item.

Enable PLC

- 1 Open the "PLC & I/O" menu.
- 2 Turn the operating knob until the "Enable PLC" menu item appears.
- 3 Press the operating knob in order to select the menu item.

Enable I/O

- 1 Open the "PLC & I/O" menu.
- 2 Turn the operating knob until the "Enable I/O" menu item appears.
- 3 Press the operating knob in order to select the menu item.

Block PLC and I/O

- 1 Open the "PLC & I/O" menu.
- 2 Turn the operating knob until the "Blocking PLC + I/O" menu item appears.
- 3 Press the operating knob in order to select the menu item.

3.13.1 List of possible conditions

Condition	Meaning	Condition	Meaning
E1	Input 1 = 1	T1	Timer 1 elapsed
E2	Input 2 = 1	T2	Timer 2 elapsed
E3	Input 3 = 1	/T1	Timer 1 running
E4	Input 4 = 1	/T2	Timer 2 running
E5	Input 5 = 1	TDC	Top dead centre reached
E6	Input 6 = 1	/TDC	Top dead centre not reached
E7	Input 7 = 1	BDC	Bottom dead centre reached
E8	Input 8 = 1	/BDC	Bottom dead centre not reached
/E1	Input 1 = 0	OK	Part OK
/E2	Input 2 = 0	NOK	Part not OK
/E3	Input 3 = 0	<F1	Force smaller than force threshold below
/E4	Input 4 = 0	>F1	Force greater than force threshold below
/E5	Input 5 = 0	<F2	Force smaller than force threshold above
/E6	Input 6 = 0	>F2	Force greater than force threshold above
/E7	Input 7 = 0	DC0	Down counter = 0
/E8	Input 8 = 0	DCG	Down counter greater than 0
N1	Cam 1 = 1	TR	System triggered
N2	Cam 2 = 1	/TR	System not triggered
N3	Cam 3 = 1		
N4	Cam 4 = 1		
N5	Cam 5 = 1		
N6	Cam 6 = 1		
/N1	Cam 1 = 0		
/N2	Cam 2 = 0		
/N3	Cam 3 = 0		
/N4	Cam 4 = 0		
/N5	Cam 5 = 0		
/N6	Cam 6 = 0		

3.13.2 List of possible commands

Command	Parameter
O1	Output 1
O2	Output 2
O3	Output 3
O4	Output 4
O5	Output 5
O6	Output 6
O7	Output 7
O8	Output 8
/O1	Reset output 1
/O2	Reset output 2
/O3	Reset output 3
/O4	Reset output 4
/O5	Reset output 5
/O6	Reset output 6
/O7	Reset output 7
/O8	Reset output 8
T1	Set timer 1 0.1 – 9.9 sec. (Input 1 = 0.1 sec)
T2	Set timer 2 0.1 – 9.9 sec.
/T1	Reset timer 1
/T2	Reset timer 2
JMP	Jump to target line
BE	Set beep
/BE	Reset beep
LO	Switch OK LED on
LN	Switch NOK LED on
/L	Switch LEDs off
CN+	NOK counter +1
CO+	OK counter +1
AE	Acknowledge error

3.14 "Cam" menu

This menu is only present on the ForceMaster 9110 with the step chain option.

The cams are an extension to the PLC. The PLC can query the electronic cams, and in that way control automation procedures.

There is more information in Section 3.18, "Cam switching mechanism".

You can make the following selections in the sub-menus:

Programming	
Next cam	Select this sub-menu item in order to edit the next cam.
Cam start	Select this sub-menu item to set the beginning of the cam.
Cam end	Select this sub-menu item to set the end of the cam.
Delete	
	Delete the complete setting with this sub-menu item if you want to create an entirely new cam program.

Programming cams

- 1 Open the "Cams" menu.
- 2 Press the operating knob in order to select the "Program" menu item.
- 3 Turn the operating knob until the "Cam start" menu item appears.
- 4 Press the operating knob in order to select the menu item.
- 5 Turn the operating knob in order to set the start value that you want.
- 6 Press the operating knob to confirm the value.
- 7 Press the operating knob in order to select the "End cam" menu item.
- 8 Turn the operating knob in order to set the end value that you want.
- 9 Press the operating knob to confirm the value.
- 10 Press the operating knob in order to select the "Next cam" menu item.
- 11 Repeat steps 3 to 10 until you have set all the cams that you want to.

Deleting cams

- 1 Open the "Cams" menu.
- 2 Turn the operating knob until the "Delete" menu item appears.
- 3 Press the operating knob in order to select the menu item.
- 4 Turn the operating knob until the "Yes" menu item appears.
- 5 Press the operating knob in order to select the menu item.

3.15 Measuring and adjusting

The ForceMaster 9110 operates in two principal ways:

- 1) Measuring mode
- 2) Setup menu

The measuring mode is automatically active after switching on unless there is a MasterCard in the card reader. In measuring mode, you can select different information windows by pressing the operating knob.

The values set in the ForceMaster 9110 cannot be changed unless a MasterCard is inserted in the device. You can only get to the settings menu if you have the appropriate authority by having the MasterCard.

You get into measuring mode from the settings menu by pressing the operating knob when the display is showing either "MENU start" or MENU". In that case, the ForceMaster 9110 changes automatically into measuring mode after five seconds.

If measuring mode is left, and the MasterCard removed, the ForceMaster 9110 can no longer be adjusted.

3.16 Force alarms

If auxiliary energy (compressed air or hydraulic power) are used for pressing, the ForceMaster 9110 can protect against excessive forces.

There are two force alarms for this purpose. Both force alarms set output 8, and have a reaction time of about 1 millisecond. The occurrence of the alarm is indicated by an error message.

3.16.1 Force alarm 1

Force alarm 1 is effective from top dead centre of the press onwards until the ForceMaster 9110 detects the trigger. Once the trigger point has been reached, this alarm can no longer be activated.

Force alarm 1 is therefore active when a part that is to be pressed is not positioned properly, as a result of which the force shows spikes.

On a press using auxiliary energy, this alarm can be used to bring about an immediate halt or to initiate a return stroke. This allows damage to the workpiece or the press to be prevented.

3.16.2 Force alarm 2

Force alarm 2 is always effective. It is useful if you want to protect your workpiece, tool or the press itself.

On a press using auxiliary energy, this alarm can be used to bring about an immediate halt or to initiate a return stroke. This allows damage to the workpiece, or the press to be prevented.

3.17 Step chain controller (option)

The integrated step chain controller provides a good way of making even simple workstations more productive.

The range of functions has been kept simple. The number of programming steps is limited to 60. The step chain controller operates according to the step chain principle. If the condition at the beginning of a line is satisfied, the command on that line is executed.

The step chain controller has 8 outputs, 7 inputs, and an emergency input. All the inputs can be programmed with all the outputs. Internal signals, such as TDC, BDC, OK, NOK and others are generated, and can be combined with other signals.

Possible conditions and commands will be found in Section 6.3 "PLC & IO".

3.18 Cam switching mechanism

It is often helpful to add automated operations to a manual press.

Examples:

- When the press plunger moves down, the workpiece is fixed pneumatically.
- A welding pulse is triggered when the lowest point is reached.
- When the press plunger moves upwards, the workpiece is ejected pneumatically.

Control procedures of this type can be implemented easily using the optional cam switching mechanism.

Six freely programmable cams are available. Each of these cams is defined by a cam start and a cam end. Control signals can be triggered by these cams. The cam signals can exclusively be used through the step chain controller.

If the programmed value is positive, then the reaction occurs during the downwards movement of the press. If the programmed value is negative, then the reaction occurs during the upwards movement of the press.

Examples:

Cam start	Cam end	Function
20.2 mm	30.3 mm	Press movement downwards: cam activation at 20.2 mm Press movement downwards: cam deactivation at 30.3 mm
-35.5 mm	-16.6 mm	Press movement upwards: cam activation at 35.5 mm Press movement upwards: cam deactivation at 16.6 mm
38.8 mm	-36.6 mm	Press movement downwards: cam activation at 38.8 mm Press movement upwards: cam deactivation at 36.6 mm
-10.1 mm	12.2 mm	Press movement upwards: cam activation at 10.1 mm Press movement downwards: cam deactivation at 12.2 mm

If the electrical power supply to the ForceMaster 9110 is to be used for switching, pins 1 and 2 must be bridged together, as must pins 25 and 24. An input is activated through an electrical contact from p 2 to the input pin.

The procedure for setting the cams will be found in Section 6.4 "Cams" menu".

3.19 I/O interface

3.19.1 Connector pin assignments

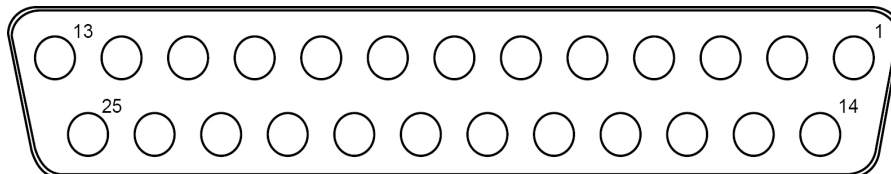

Pin	Signal	Meaning
1	U+	Supply voltage + 24 V
2	U+ (A)	Common contact for all outputs U+
3	A1	OK
4	A2	Error
5	A3	Force
6	A4	Displacement
7	A5	Too high
8	A6	Force in measuring window OK
9	A7	Ready to measure (blocking magnet)
10	A8	Alarm received
11		
12		
13		
14		
15		
16	E8	Emergency off for International PLC operation
17	E7	Not evaluated by the ForceMaster 9110
18	E6	Not used
19	E5	Not used
20	E4	Not used
21	E3	Not used
22	E2	Not used
23	E1	Error acknowledgement (100 ms pulse)
24	GND (E)	Common contact for all inputs
25	GND	Supply voltage

If the electrical power supply to the ForceMaster 9110 is to be used for external signals, pins 1 and 2 must be bridged together, as must pins 25 and 24.

The procedure for setting the cams will be found in Section 6.4."Cam" menu.

3.19.2 I/O signal combinations

"Force-displacement" measuring mode with gateways

Signals	Meaning
A2 + A3	Force-displacement gateway error
A1	Measurement OK
A8	Force 1 or 2 has been exceeded (even if measurement has not started)
A7	Ready for measurement

"Force-displacement" measuring mode with force thresholds, or "Force-time"

Signals	Meaning
A2 + A3	- Force too small (with normal displacement and threshold) - BSU not reached - BSO exceeded BE exceeded
A2 + A3 + A5	- Force too large with threshold - Gateway violated
A2 + A4	- Force too small (with very small displacement and threshold) - Peening displacement to small - KSO exceeded - Forced to small (start of measurement not reached)
A2 + A4 + A5	End of measurement not reached
A1	Measurement OK
A6	Force between KSU and KSO (even when measurement has not started!)
A7	Ready for measurement
A8	Force 1 or 2 has been exceeded (even if measurement has not started)

In addition to setting the outputs, the error messages are also displayed. Since the amount of space on the display is limited, only one of the error messages available internally is displayed. As a result, the same error message may be associated with a different pattern of set outputs.

Note

If one of the two alarm monitors is active, then output A8 is always reserved for the status indication! This is true even when the step chain function is active, with PLC+I/O blocked, or with an activated I/O function! The output A8 must not then be used in the step chain function!

3.20 Switching on procedure

Note

Only change the sensors when the equipment is switched off. Otherwise it cannot be guaranteed that the measured values are correct. The sensors are only detected when switching on.

Once the ForceMaster 9110 has been switched on, it is ready for use after about 10 seconds.

- The welcome text "HELLO" appears on the display.
- The ForceMaster 9110 carries out a self-test. It checks whether the sensors from the last autoconfiguration are still connected.
- Information about the firmware version and the item number is displayed.
- The measurements of force and displacement appear. The device is ready to use.

If the sensors have been changed, the device recognizes this, and the message "Sensors have been changed" appears. Perform an autoconfiguration if the sensors have been changed.

If the calibration interval of two years for one or more of the parts of the measuring system has elapsed, the message "Load cell (or Displacement sensor or ForceMaster 9110) calibration service" appears.

This is a reminder that a quality assurance systems such as the ForceMaster 9110 must be re-calibrated regularly. Clear this message with the operating knob. It is only shown for your benefit, and does not have any effect on the measuring function. This function can be deactivated.

If the ForceMaster 9110 still has an error saved from the last time it was operating, the corresponding error message appears. This message cannot be cleared without a MasterCard. It only appears if the error acknowledgement "with MasterCard and marker" is set.

ForceMaster 9110

4. Initial commissioning

4.1 Fitting the load cell to the manual press



This is how it works

- 1 Push the supplied catch from the 5501-Z004 assembly kit from the peg side, over the load cell.
- 2 Clamp the catch carefully (max. tightening torque 3 Nm) to the upper edge of the load cell.



Mounting the catch on the load cell

- 3 If there is a pressing tool on the manual press, remove it.
- 4 Push the press head upwards by a distance equal to the height of the load cell (depending on the measuring range).
- 5 Insert the load cell into the press plunger and fasten it with the grub screw that is in the stamp.
- 6 Insert your pressing tool from underneath into the load cell, and fasten it with the grub screw that is in the sensor. If there is a pressing tool on the manual press, remove it.



Push the press head upwards



Insert the sensor and the pressing tool

4.2 Fitting the displacement measurement system (DMS) to the manual press

- 1 Fit the adapter for the displacement sensor on the side of the press.
- 2 Use the 5501-Z004 adapter from the assembly kit supplied.

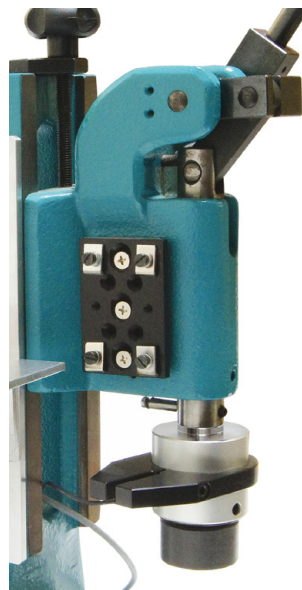

Adapter plate for displacement measurement system (DMS) on the press

- 3 Push the displacement sensor with the probe tip downwards into the adapter (typical application).
The probe tip must touch the catch that is already mounted on the load cell.
- 4 Push the displacement sensor downwards (the press is in the upper position) until the displacement sensor's probe tip is firmly against its upper stop (1-2 mm difference).



Displacement measurement system (DMS) in the upper position

ForceMaster 9110

- 5 Check the lower press function (bottom dead centre BDC), by carefully moving the press plunger downwards.

Prerequisite: The displacement sensor must move freely, without transverse force, and must not reach its lower stop at BDC. It is necessary to make sure that the probe tip is lying against the catch of the load cell.



Displacement measurement system (DMS) in the lower position

If a correction run is carried out, you will have to make some readjustment to the displacement sensor. The aim is for the displacement sensor to be able to move freely between the upper and lower positions of the press without reaching either of its stops. Since the system deliberately provides a large number of adjustment options (Moving the catch, displacement sensor and press head), you will soon have found the correct position for the displacement sensor.

- 6 After any necessary readjustment/correction of the alignment has been done, fasten finally all the relevant fitted parts (catch, displacement sensor, press head if necessary).

The sensors are now mounted on the manual press and are mechanically adjusted for the parts that are to be pressed.

- 7 Connect the sensors to the ForceMaster 9110.
- 8 Switch the ForceMaster 9110 on.

4.3 Setting up the measurement chain on the ForceMaster 9110

The message "sensors have been changed" is shown on the display after a self-test.

- 1 Press the operating knob to clear this message.

!!sensors have
been changed !!

In order to train the measurement chain it is necessary to carry out an **"autoconfig"**. As a result, the ForceMaster 9110 automatically sets the evaluation elements for the part that is to be pressed.

- 2 To carry out the autoconfig, insert the MasterCard into the card reader, and turn the operating knob to the right until **"AutoConfig"** appears on the display.

AutoConfig

- 3 Push the operating knob in order to open the next sub-menu, "Step1 teach-in".
- 4 Press the operating knob again.

The display will show:

Step1 teach-in
wait: down

- 5 Carry out a pressing operation.

After you have pressed a part, the display will show "Step1 teach-in wait: up" before you move the punch back to the top.

Step1 teach-in
wait: up

When the pressing operation is complete, the numeric display shows "Step2 >set mode".

Step2
>set mode

- 6 Turn the operating knob until you reach the following display.

AutoConf. ready
dir. to meas.

The ForceMaster 9110 has saved the values it has learned, and is ready for measuring. You can start production, with supervision.

ForceMaster 9110





It may be necessary to correct the values learnt through the autoconfiguration. If necessary, these can be manually adjusted – see Section 3.11.3.

5. Measurement

In measuring mode you can choose between various information windows. Press the operating knob to move from one window to the next.

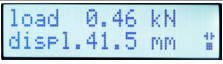
After the "Max. values" window, the current values appear again.

You can choose between the following information windows:

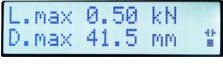
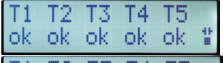
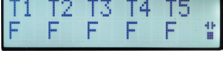
Measuring mode		
	Current values	In this window you see the current values for force displacement.
	Last operation	In this window you can see whether the last operation was OK or NOK.
	Ok parts, nok parts	In this window you can see how many operations were OK and how many were NOK.
	Parts total	In this window you see how many parts have been checked altogether.
	F1, F2, Fmes	F1: Status of force threshold 1 Possible values are low or ok F2: : Status of force threshold 2 Possible values are high or ok high: force threshold was exceeded low: force threshold was not reached ok: evaluation OK Fmes: the force with which the evaluation was carried out.
	Max. values	In this window you see the maximum force and the maximum displacement that occurred during the last pressing operation.
 	T1 T2 T3 T4 T5	You see the evaluation of the gateways here, if activated.

Retrieving information in measuring mode



This is how it works

- 1 In measuring mode, press the operating knob as often is necessary for the desired information to appear on the display.

In measuring mode, an error that occurs during the pressing operation is shown immediately as a message on the display. You must acknowledge this error message (with or without MasterCard, depending on the setting). After acknowledging the error the selected information window appears again.

ForceMaster 9110

An attention signal sounds as soon as you produce a faulty part and (deliberately or accidentally) do not acknowledge this procedure. Operating the press again immediately results in a further error message.

In addition, the red lamp flashes in order to provide a further indication that a faulty part has been produced. After acknowledging the error message, the red lamp continues to flash in order to remind you that the last part that was produced was faulty.

Error messages and their meaning

Internal fault number	Displayed text	Full text	Meaning
7	Pdisp too small	Peening displacement too small	The relative peening displacement was smaller than specified.
8	Pdisp too large	Peening displacement too large	The relative peening displacement was larger than specified.
9	ESO exceeded	Thread in threshold above exceeded	The thread in force was larger than specified.
11	BE exceeded	Block end exceeded	The insertion displacement was larger than the value for the block end.
12	BSO exceeded	Block threshold above exceeded	The blocking force was larger than the block threshold above.
13	BSU not reached	Block threshold below not reached	The blocking force has not reached the block threshold below.
14	Force too large	Force too large	The force has exceeded the upper threshold in the measuring window.
15	Force too small	Force too small	The force did not reach the lower threshold in the measuring window.
16	ME not reached	End of measurement not reached	The end of the measuring window was not reached.
18	KSU violated	Force threshold below violated	The force did not reach the lower threshold in the measuring window.
19	Gateway violated	Gateway violated	Either the upper or the lower force limit was violated in one of the 5 gateways.

ForceMaster 9110

6. Configuring the ForceMaster 9110 settings

You can only reach the settings menu if the MasterCard is inserted in the card reader.

Opening one of the sub-menus



This is how it works

- 1 Insert the MasterCard into the card reader with the contacts pointing towards the display.
- 2 Turn the operating knob until the sub-menu you want appears.
- 3 Press the operating knob in order to make settings in the sub-menu you want.

The individual sub-menus are described in more detail further down in this document.

6.1 "Counter" menu

You can make the following settings in the Counter sub-menu:

display		
	OK parts	Number of good parts
	NOK parts	Number of bad parts
	Total parts	Total of all parts
	Down counter	Status of the down counter
	D-set	Initial status of the down counter
	Tot. strokes	Total number of strokes
delete		
	Parts counters	Sets the OK counter, the NOK counter and the total counter to zero.
	Down counter	Resets the down counter to the value specified under sub-menu item "D-set".
set		
	Down counter	Sets the initial value for the down counter. The down counter allows you to have a freely editable message shown on the display after the number of working cycles that you specify. When the message appears, it is necessary for it to be confirmed at the press. Values 0 ... 9999
	Down c. text	Specifies the text that is to appear when the down counter has counted down to zero. Values 0 ... 9 or Aa ... Zz

Retrieving the value of a counter

- 1 Open the "Counters" menu.
- 2 Press the operating knob in order to select "Display".
- 3 Turn the operating knob until the value you want appears.

Clearing the parts counter

- 1 Open the "Counters" menu.
- 2 Turn the operating knob until the "Clear" menu item appears.
- 3 Press the operating knob in order to select the menu item.
- 4 Press the operating knob in order to select "Parts count".
The message "Parts counter cleared" appears.
- 5 Press the operating knob to acknowledge the message.

Setting the down counter

- 1 Open the "Counters" menu.
- 2 Turn the operating knob until the "Set" menu item appears.
- 3 Press the operating knob in order to select the menu item.
- 4 Press the operating knob in order to select the "Down counter" menu item.
- 5 Turn the operating knob as long as necessary to see the number that you want to set.
- 6 Press the operating knob to confirm the setting.

Entering text for the down counter

- 1 Open the "Counters" menu.
- 2 Turn the operating knob until the "Set" menu item appears.
- 3 Press the operating knob in order to select the menu item.
- 4 Turn the operating knob until the "Down counter text" menu item appears.
- 5 Enter the text. See Section 3.10.4, Entering text and numbers.
- 6 Turn the operating knob until "END input?" appears.
- 7 Press the operating knob to confirm the input.

6.2 USB stick (option)

6.2.1 Operation with a USB stick

This section is only relevant if the interface for the USB stick is present.

A USB stick is not necessary to operate the ForceMaster 9110.

The USB stick inserted into the ForceMaster 9110 must be formatted.

If a USB stick is inserted, then the result of the last operation is written into the current job file after every operation. If one is present, a lamp on the stick flashes in order to show that storage is being carried out on the stick.



Caution

Do not switch the device off or withdraw the USB stick while storage is taking place or the stick's operating lamp is flashing.

This will result in loss of data and to problems storing data on the stick.

If you have also selected curve logging with the stick inserted, then not only is the job file written, but a graphic file is generated for every operation.

Note

The USB stick must be formatted as FAT. This permits a maximum storage capacity of 2 GB.

If a large quantity of data is already stored on the stick, the ForceMaster 9110 takes longer to establish its data structure.

For fast working, the stick should contain as little data as possible. Existing data is basically of no concern.

ForceMaster 9110

6.2.2 "USB stick" menu

You can make the following settings in the "USB stick" menu:

USB status		
	USB module	"OK" means that a USB module is present, and is working properly. "NOK" means that either no USB module is present, or that it is faulty.
	USB stick	"OK" means that the USB stick is present. "Low" means that there is too little memory capacity on the stick. "NP" (not possible) means that the stick is faulty. "No USB stick" means that no stick is inserted.
	"Cap 1015.0 MB"	Indicates the storage capacity of the USB stick (in this case 1 GB as an example).
	"1014.1 MB free"	Indicates the available memory space (in this case 1014.1 MB as an example).
	"Folder 23_03_08"	Indicates the current folder where storage is presently taking place (in this case, folder 23_03_08 as an example).
	"JOB001.CSV"	Indicates the current job file to which data is being written (in this case JOB001.CSV as an example).
	"GRA011.CSV"	Indicates the next graphic file into which the next pressing operation will be written (in this case GRA011.CSV as an example).
Without stick: OK		
		If this menu item is enabled, the ForceMaster 9110 will also make measurements when no USB stick is inserted, or if writing to the USB stick is not possible.
Without stick: NOK		
		If this menu item is enabled, the ForceMaster 9110 will not take measurements if it is not possible to store the data on the stick. An error message appears instead, and a warning tone is sounded. Work cannot continue until a USB stick on which it is possible to write is inserted.
Curve -> stick		
		The most recent curve is stored on the stick under this menu item, so that a pressing operation can be analyzed graphically.

100 C -> stick		<p>If this menu item is enabled, the following 100 operations are stored on the stick as a curve file. Recording will stop after these 100 operations. This is intended for product start-up, in order to record this critical phase graphically.</p>
100 C -> STOP		<p>If this menu item is enabled, the recording of 100 curves is interrupted. This menu item inactivates the previous one.</p>
All C -> stick		<p>If this menu item is enabled, the following operations are stored on the stick as a curve file. This function is useful if graphical evaluations of critical pressing operations on high-value parts are to be carried out over a long period. Note that the ForceMaster 9110 is not able to measure during the recording time. The graphic files also take up a great deal of space on the stick.</p>
All C -> STOP		<p>If this menu item is enabled, the recording of all the curves is interrupted. This menu item inactivates the previous one.</p>



This is how it works

Retrieving information from the USB status

- 1 Open the "USB stick" menu.
- 2 Press the operating knob in order to select "USB status".
- 3 Turn the operating knob until the information you want appears.

Setting that measurements are also possible without a USB stick

- 1 Open the "USB stick" menu.
- 2 Turn the operating knob until the "Without stick: OK" menu item appears.
- 3 Press the operating knob in order to select the menu item.

Setting that measurements are only possible with a USB stick

- 1 Open the "USB stick" menu.
- 2 Turn the operating knob until the "Without stick: NOK" menu item appears.
- 3 Press the operating knob in order to select the menu item.

Storing the last measurement curve on the stick

- 1 Open the "USB stick" menu.
- 2 Turn the operating knob until the "Curve -> stick" menu item appears.
- 3 Press the operating knob in order to select the menu item.

Storing the next 100 measurement curves on the stick

- 1 Open the "USB stick" menu.
- 2 Turn the operating knob until the "100 C -> stick" menu item appears.
- 3 Press the operating knob in order to select the menu item.

Interrupting storage of the next 100 measurement curves on the stick

- 1 Open the "USB stick" menu.
- 2 Turn the operating knob until the "100 C -> STOP" menu item appears.
- 3 Press the operating knob in order to select the menu item.

Storing all measurement curves on the stick

- 1 Open the "USB stick" menu.
- 2 Turn the operating knob until the "All C -> stick" menu item appears.
- 3 Press the operating knob in order to select the menu item.

Interrupting storage of all measurement curves on the stick

- 1 Open the "USB stick" menu.
- 2 Turn the operating knob until the "All C -> STOP" menu item appears.
- 3 Press the operating knob in order to select the menu item.

ForceMaster 9110

6.2.3 Data storage example

Text in the data store	Meaning
15:36:27 11_02_10 10334455 9.014	Time, date, Snr.FM, Vers.SW. FM
Order data	
PART.NO	Part number
ORDER.NO	Order number
ORDER.REF	Order reference
CUSTOMER	Customer name
Limits	
265 1 0	Recording time[1], IO marker[2], error number[3]
52 1000	Sensor displacement max., sensor force max.
7 2 0	Measuring mode[4], blocking mode[5], thread in force mode[6]
30.67 38.72 213 320	Measurement start, measurement end, force threshold below, force threshold above
37.91 39.52 362 542	Block start, block end, block threshold below, block threshold above
30.67 213	Feet-in force end, upper thread in force threshold
37.91 39.52	Peening displacement min., peening displacement max.
15.63	Trigger point displacement
29.86 0.0 106.7	1. Gateway position, gateway min., gateway max.
32.28 50.9 157.6	2. Gateway position, gateway min., gateway max.
33.89 99.1 205.9	3. Gateway position, gateway min., gateway max.
35.50 140.8 247.5	4. Gateway position, gateway min., gateway max.
37.11 187.5 294.2	5. Gateway position, gateway min., gateway max.
Curve data	
28.89 28.9	Displacement value, force value
29.02 32.3	Displacement value, force value
29.08 35.5	Displacement value, force value
29.16 38.4	Displacement value, force value
29.26 41.1	Displacement value, force value
29.36 41.6	Displacement value, force value
29.50 45.8	Displacement value, force value
29.66 48.0	Displacement value, force value
29.63 51.4	Displacement value, force value
29.68 48.5	Displacement value, force value
29.64 48.2	Displacement value, force value
Etc. etc.	Displacement value, force value

6.3 "PLC & IO" menu

This menu is only present on the ForceMaster 9110 with the step chain option. The step chain is a very good way of automating small workstations economically.

See Section 3.17 "Step chain controller (option)" for more information.

You can make the following selections in the sub-menus:

Reset PLC		
		This sub-menu item resets the PLC.
See program		
		This sub-menu item allows you to see the PLC program, but not to change it. This lets you get a quick overview of the program. By turning the knob, you can navigate through the lines. Press the operating knob to return to the main menu.
Edit program		
	Next STEP	Select this sub-menu item in order to edit the next program step.
	Entry condition	Select this sub-menu item in order to specify the condition for the program step. You will find a list of possible conditions in Section 6.3.1 List of possible conditions.
	Entry command	Select this sub-menu item in order to specify the command in the program step. You will find a list of possible commands in Section 6.3.2 List of possible commands.
	Entry parameter	Select this sub-menu item in order to specify the parameter for the program step.
	Entry END	Select this sub-menu item in order to stop processing the program step.
	Previous STEP	Select this sub-menu item in order to edit the previous program step.
Delete program		
		Select this sub-menu item in order to delete the program entirely.
Enable PLC		
		You can enable the PLC in this sub-menu. The PLC executes the program.
Enable I/O		
		The standard error message signals are provided at the outputs through this menu item.
Blog PLC + I/O		
		Activate this menu item in order to stop receiving signals at the outputs.



This is how it works

Reset PLC

- 1 Open the "PLC & I/O" menu.
- 2 Press the operating knob in order to select the "Reset PLC" menu item.

See program

- 1 Open the "PLC & I/O" menu.
- 2 Turn the operating knob until the "See program" menu item appears.
- 3 Press the operating knob in order to select the menu item.
- 4 Turn the operating knob in order to navigate through the lines of the menu.
- 5 Press the operating knob to return to the main menu.

Edit program

- 1 Open the "PLC & I/O" menu.
- 2 Turn the operating knob until the "Edit program" menu item appears.
- 3 Press the operating knob in order to select the menu item.
- 4 Turn the operating knob until the "Entry condition" menu item appears.
- 5 Press the operating knob in order to select the menu item.
- 6 Turn the operating knob in order to select the condition that you want.
- 7 Press the operating knob to confirm the condition.
- 8 Press the operating knob in order to select the "Entry command" menu item.
- 9 Turn the operating knob in order to select the command that you want.
- 10 Press the operating knob to confirm the command.
- 11 Press the operating knob in order to select the "Entry parameter" menu item.
- 12 Turn the operating knob in order to set the parameter that you want.
- 13 Press the operating knob in order to select the "Next STEP" menu item.
- 14 Repeat steps 2 to 13 until you have written the program through to the end.
- 15 If you want to correct an earlier step, turn the operating knob until "Previous STEP" appears. Press the operating knob. Repeat this procedure until the step that needs correcting appears.
- 16 Turn the operating knob until the "END entry" menu item appears.

- 17 Press the operating knob in order to select the menu item.

Delete program

- 1 Open the "PLC & I/O" menu.
- 2 Turn the operating knob until the "Delete program" menu item appears.
- 3 Press the operating knob in order to select the menu item.
- 4 Turn the operating knob until the "Yes" menu item appears.
- 5 Press the operating knob in order to select the menu item.

Enable PLC

- 1 Open the "PLC & I/O" menu.
- 2 Turn the operating knob until the "Enable PLC" menu item appears.
- 3 Press the operating knob in order to select the menu item.

Enable I/O

- 1 Open the "PLC & I/O" menu.
- 2 Turn the operating knob until the "Enable I/O" menu item appears.
- 3 Press the operating knob in order to select the menu item.

Block PLC and I/O

- 1 Open the "PLC & I/O" menu.
- 2 Turn the operating knob until the "Blocking PLC + I/O" menu item appears.
- 3 Press the operating knob in order to select the menu item.

ForceMaster 9110

6.3.1 List of possible conditions

Condition	Meaning	Condition	Meaning
E1	Input 1 = 1	T1	Timer 1 elapsed
E2	Input 2 = 1	T2	Timer 2 elapsed
E3	Input 3 = 1	/T1	Timer 1 running
E4	Input 4 = 1	/T2	Timer 2 running
E5	Input 5 = 1	TDC	Top dead centre reached
E6	Input 6 = 1	/TDC	Top dead centre not reached
E7	Input 7 = 1	BDC	Bottom dead centre reached
E8	Input 8 = 1	/BDC	Bottom dead centre not reached
/E1	Input 1 = 0	OK	Part OK
/E2	Input 2 = 0	NOK	Part not OK
/E3	Input 3 = 0	<F1	Force smaller than force threshold below
/E4	Input 4 = 0	>F1	Force greater than force threshold below
/E5	Input 5 = 0	<F2	Force smaller than force threshold above
/E6	Input 6 = 0	>F2	Force greater than force threshold above
/E7	Input 7 = 0	DC0	Down counter = 0
/E8	Input 8 = 0	DCG	Down counter greater than 0
N1	Cam 1 = 1	TR	System triggered
N2	Cam 2 = 1	/TR	System not triggered
N3	Cam 3 = 1		
N4	Cam 4 = 1		
N5	Cam 5 = 1		
N6	Cam 6 = 1		
/N1	Cam 1 = 0		
/N2	Cam 2 = 0		
/N3	Cam 3 = 0		
/N4	Cam 4 = 0		
/N5	Cam 5 = 0		
/N6	Cam 6 = 0		

6.3.2 List of possible commands

Command	Parameter
O1	Output 1
O2	Output 2
O3	Output 3
O4	Output 4
O5	Output 5
O6	Output 6
O7	Output 7
O8	Output 8
/O1	Reset output 1
/O2	Reset output 2
/O3	Reset output 3
/O4	Reset output 4
/O5	Reset output 5
/O6	Reset output 6
/O7	Reset output 7
/O8	Reset output 8
T1	Set timer 1 0.1 – 9.9 sec. (Input 1 = 0.1 sec)
T2	Set timer 2 0.1 – 9.9 sec.
/T1	Reset timer 1
/T2	Reset timer 2
JMP	Jump to target line
BE	Set beep
/BE	Reset beep
LO	Switch OK LED on
LN	Switch NOK LED on
/L	Switch LEDs off
CN+	NOK counter +1
CO+	OK counter +1
AE	Acknowledge error

6.4 "Cam" menu

This menu is only present on the ForceMaster 9110 with the step chain option.

The cams are an extension to the PLC. The PLC can query the electronic cams, and in that way control automation procedures.

There is more information in Section 3.18 „Cam switching mechanism“.

ForceMaster 9110

You can make the following selections in the sub-menus:

Programming	
Next cam	Select this sub-menu item in order to edit the next cam.
Cam start	Select this sub-menu item to set the beginning of the cam.
Cam end	Select this sub-menu item to set the end of the cam.
Delete	
	Delete the complete setting with this sub-menu item if you want to create an entirely new cam program.

Programming cams

- 1 Open the "Cams" menu.
- 2 Press the operating knob in order to select the "Program" menu item.
- 3 Turn the operating knob until the "Cam start" menu item appears.
- 4 Press the operating knob in order to select the menu item.
- 5 Turn the operating knob in order to set the start value that you want.
- 6 Press the operating knob to confirm the value.
- 7 Press the operating knob in order to select the "End cam" menu item.
- 8 Turn the operating knob in order to set the end value that you want.
- 9 Press the operating knob to confirm the value.
- 10 Press the operating knob in order to select the "Next cam" menu item.
- 11 Repeat steps 3 to 10 until you have set all the cams that you want to.

Deleting cams

- 1 Open the "Cams" menu.
- 2 Turn the operating knob until the "Delete" menu item appears.
- 3 Press the operating knob in order to select the menu item.
- 4 Turn the operating knob until the "Yes" menu item appears.
- 5 Press the operating knob in order to select the menu item.

6.5 "CARD" menu

You can make the following selections in the sub-menus:

Read		
	ToolCard	You read a tool card with this sub-menu item. The data saved on this card is then used for the settings in the ForceMaster 9110.
	PLCCard	You read a PLC card with this sub-menu item. The data saved on this card is then used in the ForceMaster 9110 as the PLC program. At the same time the cam data saved on this card is written to the device memory.
Write		
	ToolCard	Through this sub-menu item, you save the current settings of the ForceMaster 9110 with respect to present data onto a tool card. You can label the card, and can include it with the order documentation.
	PLCCard	Through this sub-menu item you save the current PLC program and the cam settings onto a PLC card. You can label the card, and can include it with the order documentation.
Tool card direct		
	no	A MasterCard is required when loading a new program from the ToolCard.
	yes	A MasterCard is not required when loading a new program from the ToolCard. Insert a ToolCard into the card reader, and turn the operating knob to the right until you reach the Read ToolCard menu item. You can now read the ToolCard, and are taken automatically back to the measurement menu.



This is how it works

Reading the ToolCard

- 1 Open the "CARD" menu.
- 2 Press the operating knob in order to select the "Read" menu item.
- 3 Take the MasterCard out of the card reader, and insert the ToolCard that you want to read.
- 4 Press the operating knob in order to select the "Tool C" menu item. The message "CARD read" appears.
- 5 Press the operating knob to acknowledge the message.

Writing to the ToolCard

- 1 Open the "CARD" menu.
- 2 Turn the operating knob until the "Write" menu item appears.
- 3 Press the operating knob in order to select the menu item.
- 4 Take the MasterCard out of the card reader, and insert the ToolCard onto which you want to write the tool data.
- 5 Press the operating knob in order to select the "Tool C" menu item. The message "CARD written" appears.
- 6 Press the operating knob to acknowledge the message.

Reading a PLCCard

- 1 Open the "CARD" menu.
- 2 Press the operating knob in order to select the "Read" menu item.
- 3 Take the MasterCard out of the card reader, and insert the PLCCard that you want to read.
- 4 Turn the operating knob until the "PLCCard" menu item appears.
- 5 Press the operating knob in order to select the menu item. The message "CARD read" appears.
- 6 Press the operating knob to acknowledge the message.

Writing to the PLCCard

- 1 Open the "CARD" menu.
- 2 Turn the operating knob until the "Write" menu item appears.
- 3 Press the operating knob in order to select the menu item.
- 4 Take the MasterCard out of the card reader, and insert the PLCCard onto which you want to write the current PLC program.
- 5 Turn the operating knob until the "PLCCard" menu item appears.
- 6 Press the operating knob in order to select the menu item. The message "CARD written" appears.
- 7 Press the operating knob to acknowledge the message.

Enable reading a ToolCard for workers without MasterCards

- 1 Open the "CARD" menu.
- 2 Turn the operating knob until the "ToolCard direct" menu item appears.
- 3 Press the operating knob in order to select the menu item.
- 4 Turn the operating knob until the "Yes" menu item appears.
- 5 Press the operating knob in order to select the menu item.

Block reading a ToolCard for workers without MasterCards

- 1 Open the "CARD" menu.
- 2 Turn the operating knob until the "ToolCard direct" menu item appears.
- 3 Press the operating knob in order to select the "No" menu item.

6.6 "Manual settings" menu.

You can make the following selections in the sub-menus:

TR FO		<p>You can set the trigger point for the value of the force through this sub-menu item.</p> <p>You should, however, have enough experience of monitoring the pressing force to make this setting sensibly.</p>
TR DS		<p>You can set the trigger point for the value of the displacement through this sub-menu item.</p> <p>You should, however, have enough experience of monitoring the pressing force to make this setting sensibly.</p>
FO Alarm 1		<p>You can move the threshold for the force alarm 1 through this sub-menu item.</p>
FO Alarm 1		<p>You can move the threshold for the force alarm 2 through this sub-menu item.</p>

Setting the value of the force for the trigger point

- 1 Open the "Manual settings" menu.
- 2 Press the operating knob in order to select the "TR FO" menu item.
- 3 Turn the operating knob as long as necessary to see the value that you want to set.
- 4 Press the operating knob to confirm the setting.

Setting the value of the displacement for the trigger point

- 1 Open the "Manual settings" menu.
- 2 Turn the operating knob until the "TR DS" menu item appears.
- 3 Press the operating knob in order to select the menu item.
- 4 Turn the operating knob as long as necessary to see the value that you want to set.
- 5 Press the operating knob to confirm the setting..

Setting force alarm 1

- 1 Open the "Manual settings" menu.
- 2 Turn the operating knob until the "FO alarm 1" menu item appears.
- 3 Press the operating knob in order to select the menu item.
- 4 Turn the operating knob as long as necessary to see the value that you want to set.
- 5 Press the operating knob to confirm the setting.

Setting force alarm 2

- 1 Open the "Manual settings" menu.
- 2 Turn the operating knob until the "FO alarm 1" menu item appears.
- 3 Press the operating knob in order to select the menu item.
- 4 Turn the operating knob as long as necessary to see the value that you want to set.
- 5 Press the operating knob to confirm the setting.

ForceMaster 9110

6.7 "Error signals" menu



Warning

Only use the highest volume level in a working environment where hearing protection is obligatory. There is a risk of hearing damage.

You can make the following selections in the sub-menus:

Error signal		
	single beep	In this sub-menu you can choose the sound with which the device reacts to a pressing error.
	series of beeps	A repeating error signal remains active until acknowledged.
	single hoot of the horn	
	series of horn hoots	
	single siren sound	
	series of siren sounds	
Error signal volume		
	quiet	
	medium	
	loud	
	very loud	
Error acknowledgement		
	standard	In this sub-menu you can choose how the pressing error is acknowledged. Error acknowledgement without MasterCard
	with MasterCard	Errors can only be acknowledged with a MasterCard.
	with MasterCard and marker	Errors can only be acknowledged with the MasterCard. The error message remains active until switched on again.
Beep off		
		The warning tone is switched off.
Beep at BF		
		A warning tone for the operative when he presses at blocking force. When the desired blocking force is reached, a short signal tone sounds to confirm the correct force.
Beep when peening		
		A warning tone for the operative when he performs a peening operation. When the desired peening displacement is reached, a short signal tone sounds to confirm correct peening.

The large number of error signals makes it possible to detect quickly the device that is signaling an error in an environment with several ForceMaster 9110s.

Setting the type of error signal

- 1 Open the "Error signal" menu.
- 2 Press the operating knob in order to select the "Error signal" menu item.
- 3 Turn the operating knob as long as necessary to see the type of error signal that you want to set.
- 4 Press the operating knob to confirm your selection.

Setting the volume of the error signal

- 1 Open the "Error signal" menu.
- 2 Turn the operating knob until the "Error signal volume" menu item appears.
- 3 Press the operating knob in order to select the menu item.
- 4 Turn the operating knob as long as necessary to see the volume that you want to set.
- 5 Press the operating knob to confirm your selection.

Setting the type of error acknowledgement

- 1 Open the "Error signal" menu.
- 2 Turn the operating knob until the "Error acknowledgement" menu item appears.
- 3 Press the operating knob in order to select the menu item.
- 4 Turn the operating knob as long as necessary to see the type of acknowledgement that you want to set.
- 5 Press the operating knob to confirm your selection.

Setting the warning tone when the blocking force is reached

- 1 Open the "Error signal" menu.
- 2 Turn the operating knob until the "Beep at BF" menu item appears.
- 3 Press the operating knob in order to select the menu item.

Setting the warning tone when the peening displacement is reached

- 1 Open the "Error signal" menu.
- 2 Turn the operating knob until the "Beep when peening" menu item appears.
- 3 Press the operating knob in order to select the menu item.

ForceMaster 9110

Switching off the warning tone

- 1 Open the "Error signal" menu.
- 2 Turn the operating knob until the "Beep off" menu item appears.
- 3 Press the operating knob in order to select the menu item.

6.8 "Order data" menu

This data appears in the printout, and is written into the USB stick. It is also available in measuring mode.

You can make the following selections in the sub-menus:

ItemNo	
	You can enter the text for the item number here. The text appears on printouts, and in the Excel table of the job memory.
ItemDes	
	You can enter the text for the item designation here. The text appears on printouts, and in the Excel table of the job memory.
OrderNo	
	You can enter the text for the order number here. The text appears on printouts, and in the Excel table of the job memory.
Customer	
	You can enter the text for the customer's name here. The text appears on printouts, and in the Excel table of the job memory.

Entering the item number

- 1 Open the "Order data" menu.
- 2 Press the operating knob in order to select the "ItemNo" menu item.
- 3 Enter the item number. See Section 3.10.4, "Entering text and numbers".

Entering the item designation

- 1 Open the "Order data" menu.
- 2 Turn the operating knob until the "ItemDes" menu item appears.
- 3 Press the operating knob in order to select the menu item.
- 4 Enter the item number. See Section 3.10.4, "Entering text and numbers".

Entering the order number

- 1 Open the "Order data" menu.
- 2 Turn the operating knob until the "OrderNo" menu item appears.
- 3 Press the operating knob in order to select the menu item.
- 4 Enter the item number. See Section 3.10.4, "Entering text and numbers".

Entering the customer name

- 1 Open the "Order data" menu.
- 2 Turn the operating knob until the "Customer" menu item appears.
- 3 Press the operating knob in order to select the menu item.
- 4 Enter the item number. See Section 3.10.4, "Entering text and numbers".

6.9 "Statistics" menu

This menu is purely an information window. The time for the statistical information begins when the setting menu is closed, and stops when the measurement menu is closed.

You can retrieve the following information in this menu:

Statistics	
Parts per hour	
Parts per minute	
Time per part	
Time for ten parts	
Time for a hundred parts	

Retrieving statistical information

- 1 Open the "Statistics" menu.
- 2 Turn the operating knob until the information you want appears.

ForceMaster 9110

6.10 "Manual and internal settings" menu

You can make the following selections in the sub-menus:

Special displacement		
	inverse	The ForceMaster 9110 expects a rising value from the displacement sensor when the press is moving in the direction of the workpiece (downwards). Our displacement sensors are shipped such that when the press is moving downwards, the sensing pin springs out of the sensor housing. If you have chosen to mount the displacement sensor in such a way that it runs in the opposite direction, you can invert the display direction in this menu through the "inverse" menu item.
	normal	Select this menu item in order to return to the standard display direction.
	auto	Select this menu item in order to have the display direction depended automatically.
FS. Autoconfig		
		When you start an autoconfiguration, the ForceMaster 9110 takes the force as a trigger in order to detect when the pressing process starts. This standard figure is for this force to be 5% of the sensor's rated value. If you want a larger or smaller triggering force for some particular application, you can set it in this menu.
RS232 <-> USB		
	RS232	Select this menu item in order to switch from the USB interface to the RS232 interface.
	USB	Select this menu item in order to switch from the RS232 interface to the USB interface.
Cal. message		
	off	Select this menu item in order to switch the calibration message about the ForceMaster 9110 and the sensor off.
	on	Select this menu item in order to switch the calibration message about the ForceMaster 9110 and the sensor on.

Display format		
	Displacement	Select this menu item in order to choose the unit in which displacement is measured. Possibilities: millimeters, inches, free
	Force	Select this menu item in order to choose the unit in which the force is measured. Possibilities: N, pound-f, Kp, pdl.
UTK		
	Train	Train the UTK sensor to the position of the bottom dead centre of the press.
	Adjustment	Adjust the UTK sensor at the press, so that the measuring range covers the full range through which the press travels.
Standard settings		
		This sub-menu item sets the ForceMaster 9110 two standard values. This is useful when settings have been made in the various sub-menus that are inappropriate. After the standard settings have been restored, the ForceMaster 9110 is again in the state in which it was shipped.

Setting the displacement measurement for the sensing pin in compression

- 1 Open the "Internal settings" menu.
- 2 Press the operating knob in order to select the "Special displacement" menu item.
- 3 Turn the operating knob until the "Inverse" menu item appears.
- 4 Press the operating knob in order to select the menu item.

Setting the displacement measurement for the sensing pin in extension

- 1 Press the operating knob in order to select the "Special displacement" menu item.
- 2 Press the operating knob in order to select the "Normal" menu item.

Setting the trigger force

- 1 Open the "Internal settings" menu.
- 2 Turn the operating knob until the "FS autoconfig" menu item appears.
- 3 Press the operating knob in order to select the menu item.
- 4 Press the operating knob in order to select the "Force level" menu item.
- 5 Turn the operating knob in order to set the value that you want.
- 6 Press the operating knob to confirm your setting.

Selecting the RS232 interface

- 1 Open the "Internal settings" menu.
- 2 Turn the operating knob until the "RS232 <-> USB" menu item appears.
- 3 Press the operating knob in order to select the "RS232" menu item.

Selecting the USB interface

- 1 Open the "Internal settings" menu.
- 2 Turn the operating knob until the "RS232 <-> USB" menu item appears.
- 3 Press the operating knob in order to select the menu item.
- 4 Turn the operating knob until the "USB" menu item appears.
- 5 Press the operating knob in order to select the menu item.

Switching the calibration message off

- 1 Open the "Internal settings" menu.
- 2 Turn the operating knob until the "Standard settings" menu item appears.
- 3 Turn the operating knob until the "CAL message" menu item appears.
- 4 Turn the operating knob until the "Yes" menu item appears.
- 5 Press the operating knob in order to select the menu item.

Switching the calibration message on

- 1 Open the "Internal settings" menu.
- 2 Turn the operating knob until the "Standard settings" menu item appears.
- 3 Turn the operating knob until the "CAL message" menu item appears.
- 4 Turn the operating knob until the "No" menu item appears.
- 5 Press the operating knob in order to select the menu item.

Changing the displacement unit

- 1 Open the "Internal settings" menu.
- 2 Turn the operating knob until the "Display format" menu item appears.
- 3 Press the operating knob in order to select the menu item.
- 4 Turn the operating knob until the "Displacement" menu item appears.
- 5 Press the operating knob in order to select the menu item.
- 6 Turn the operating knob until the unit you want appears.
- 7 Press the operating knob in order to select the menu item.

Changing the force unit

- 1 Open the "Internal settings" menu.
- 2 Turn the operating knob until the "Display format" menu item appears.
- 3 Press the operating knob in order to select the menu item.
- 4 Turn the operating knob until the "Force" menu item appears.
- 5 Press the operating knob in order to select the menu item.
- 6 Turn the operating knob until the unit you want appears.
- 7 Press the operating knob in order to select the menu item.

Training the UTK

- 1 Open the "Internal settings" menu.
- 2 Turn the operating knob until the "Train the UTK" menu item appears.
- 3 Press the operating knob in order to select the menu item.
- 4 Bring the press, with the UTK sensor fitted, to the bottom dead centre position.
- 5 Press the operating knob in order to conclude the procedure. The UTK sensor is now tared to a value of 182°.

Adjusting the UTK

- 1 Open the "Internal settings" menu.
- 2 Turn the operating knob until the "Adjust the UTK" menu item appears.
- 3 Press the operating knob in order to select the menu item.
- 4 Bring the UTK sensor with the shaft to a position at which the entire transit path of the press is continuously displayed.
- 5 Press the operating knob in order to conclude the procedure.
- 6 Execute the "Train the UTK" menu item.

Setting to standard settings

- 1 Open the "Internal settings" menu.
- 2 Turn the operating knob until the "Standard settings" menu item appears.
- 3 Press the operating knob in order to select the menu item.
- 4 Turn the operating knob until the "Yes" menu item appears.
- 5 Press the operating knob in order to select the menu item.

6.11 "Date & time" menu

You can make the following selections in the sub-menus:

Date	The date is needed by the ForceMaster 9110 for printouts, for the job memory, and for monitoring the calibration intervals. Choose this menu item in order to set it.
Time	The time is needed by the ForceMaster 9110 for printouts and for the job memory. Choose this menu item in order to set it.

Setting the date

- 1 Open the "Date & time" menu.
- 2 Press the operating knob in order to select the "Date" menu item.
- 3 Turn the operating knob in order to set the day.
- 4 Press the operating knob to confirm the value.
- 5 Repeat steps 3 and 4 for the month and for the year.

Setting the time

- 1 Open the "Date & time" menu.
- 2 Turn the operating knob until the "Time" menu item appears.
- 3 Press the operating knob in order to select the menu item.
- 4 Turn the operating knob in order to set the hours.
- 5 Press the operating knob to confirm the value.
- 6 Repeat steps 3 and 5 for the minutes.

6.12 "Status" menu

This menu is purely an information window.

You can retrieve the following information in this menu:

Status	
Firmware version	
C	
Software version	
Version date	
Version time	

- 1 Select the "Status" menu.
- 2 Turn the operating knob until the information you want appears.

6.13 "Languages" menu

Select this menu item in order to change the language settings.

Language	
German	
English	
French	
Italian	
Hungarian	
Polish	

- 1 Select the "Languages" menu.
- 2 Turn the operating knob as long as necessary to see the language that you want to set.
- 3 Press the operating knob to confirm the set language.

7. Force-displacement curves

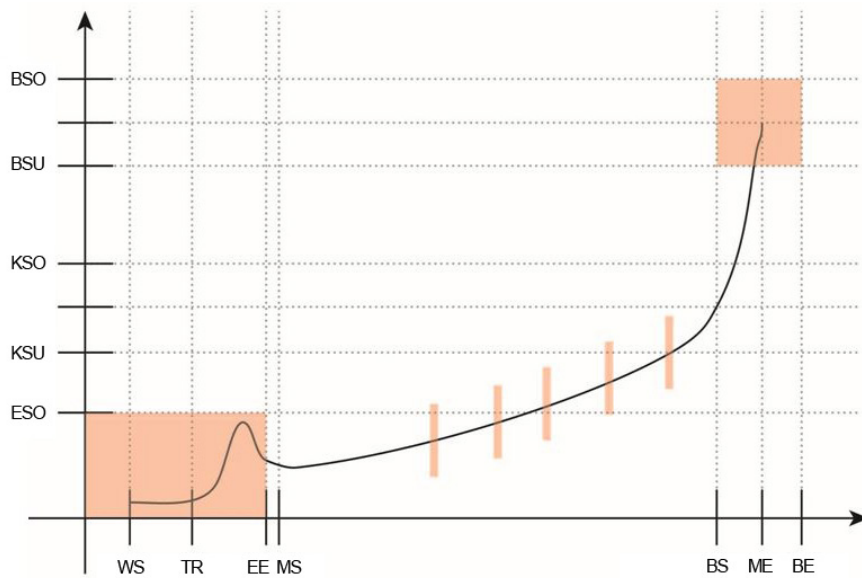



Example of a pressing curve: The thread in region is represented as a red rectangle at the start of the curve, and the blocking region as a red square at its end. The red bars symbolize the gateways.

Abbreviations:

WS = displacement start	TR = trigger
MS = measurement start	ME = measurement end
KSU = force threshold below	KSO = force threshold above
BS = block start	BE = block end
BSU = block threshold below	BSO = block threshold above
EE = end thread in	ESO = thread in threshold above

Key:

 Region	 Thread in window	 Block window	 Gateway
--	--	--	---

ForceMaster 9110

Region 1

The press moves in the direction of the workpiece, without any force being developed. It is not necessary to monitor the force in this region.



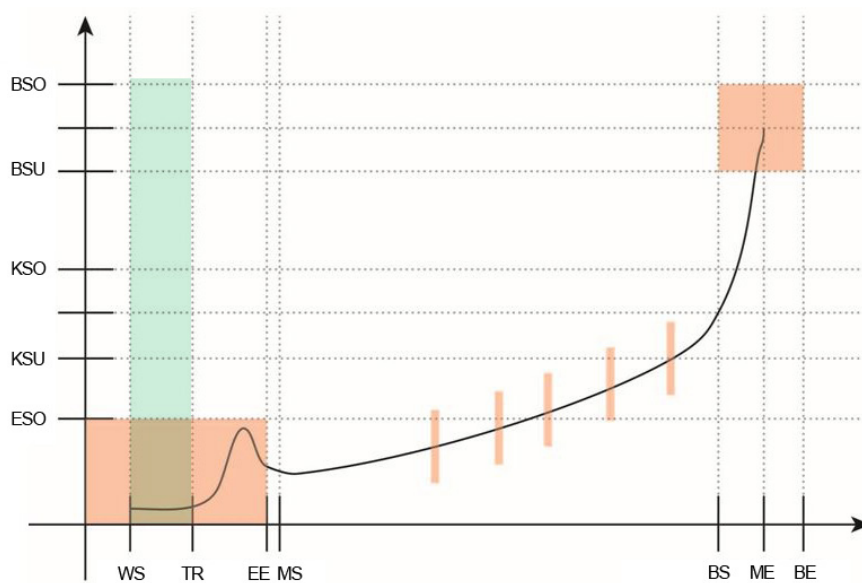

If the ForceMaster 9110 is being used in automatic presses, the Alarm force 1 can be used for collision monitoring. (See Section 3.16 "Force alarms").



Abbreviations:

WS = displacement start	TR = trigger
MS = measurement start	ME = measurement end
KSU = force threshold below	KSO = force threshold above
BS = block start	BE = block end
BSU = block threshold below	BSO = block threshold above
EE = end thread in	ESO = thread in threshold above

Key:

 Region	 Thread in window	 Block window	 Gateway
--	--	--	---

Region 2

The press meets the workpiece. This is a critical moment. In many cases an increased force occurs here, since the part that is to be pressed in must be fed into the lower part of the workpiece. That is why we refer to this force as the thread in force. It is sometimes useful to monitor the thread in force. There are also pressing-in processes that do not give rise to a thread in force.

A thread in force occurs when

- the part that is to be pressed in cannot be fed cleanly into the lower part
- there are sharp edges or burrs on both parts
- play in the pressing tool makes an exact pressing position difficult.

The thread in force has two monitoring parameters:

- force threshold above (KSO); the thread in force must not exceed this threshold
- displacement start (EE), where monitoring of the thread in force ends.

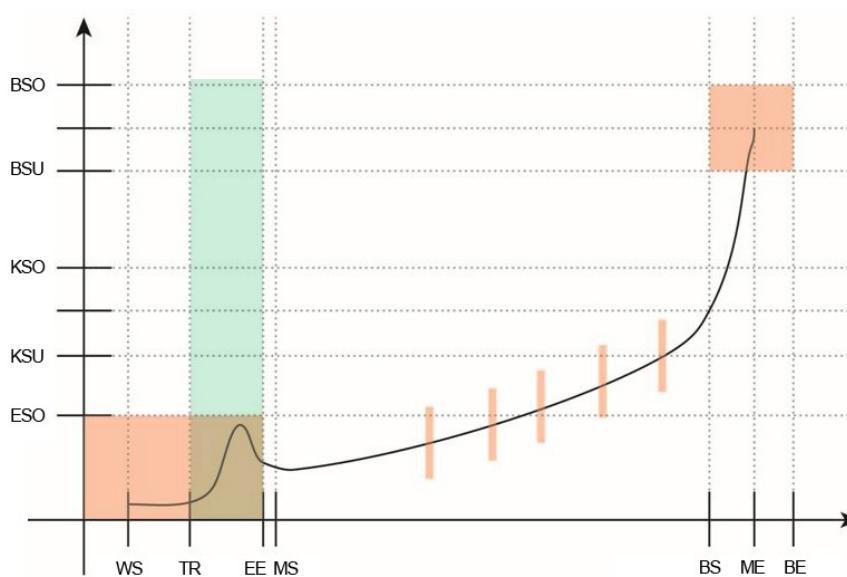

Abbreviations:

WS = displacement start	TR = trigger
MS = measurement start	ME = measurement end
KSU = force threshold below	KSO = force threshold above
BS = block start	BE = block end
BSU = block threshold below	BSO = block threshold above
EE = end thread in	ESO = thread in threshold above

Key:

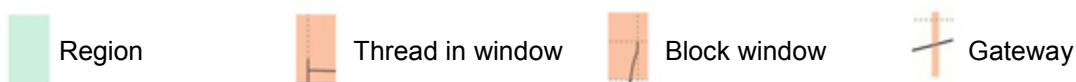

Region 3

The thread in operation is complete. The force will rise, since the frictional forces of the parts being pressed gets greater and greater. The force can vary both upwards and downwards. This is a result of surface roughness and the effects of lubricating media such as cooling agent from the machining, or even skin grease from touching the parts. Generally speaking, pressing operations in region 3 are rarely closely reproducible, although similar in trend.

Two types of monitoring are available for the actual pressing region: two force thresholds or five force gateways. (See Section 7 "Force-displacement curves").

- Force thresholds

The pressing region itself is monitored for two force thresholds.

The force threshold below (KSU) must be exceeded, since otherwise the pressing force is too small and the parts could come apart again.

The force threshold above (KSO) must not be exceeded, as otherwise the workpiece will be damaged.

- Force gateways

Gateways are force tolerance ranges that depend on displacement. The force must not be above or below this gateway at defined displacements for a good part. They are arranged at five displacement positions. The force profile must pass through these gateways. Each gateway is defined by three parameters - the position of the gateway on the displacement axis, the lower gateway point on the force axis and the upper gateway point on the force axis.

Even complicated force curves can be monitored since each gateway can be defined freely.

Monitoring using force thresholds can be set up quickly, and is suitable for most operations. Force gateways are more complicated to set up.

You can choose freely between the force threshold and gateway modes.

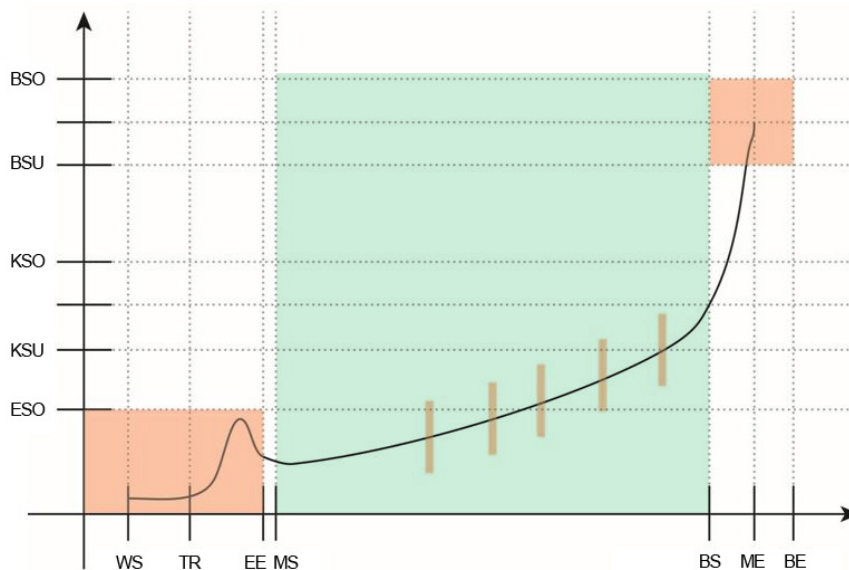

Abbreviations:

WS = displacement start	TR = trigger
MS = measurement start	ME = measurement end
KSU = force threshold below	KSO = force threshold above
BS = block start	BE = block end
BSU = block threshold below	BSO = block threshold above
EE = end thread in	ESO = thread in threshold above

Key:



Region 4

The pressing operation has been completed. However, if the part that is to be pressed in is to come against an internal stop (e.g. in a blind hole), then the part cannot be pressed in any further. The part comes up against a block, which is why we call this force the blocking force. There are reasons for monitoring this blocking region. These reasons will be considered more closely below.

The blocking force occurs when

- 1) the part being pressed in is pressed against a block (a floor)
- 2) the tool runs against a hard stop which limits the pressing position.

Blocking force does not occur when a hard stop on the press limits the pressing displacement. In this case, monitoring the blocking force does not work.

Monitoring parameters for case 1:

The block threshold below (BSU) must be exceeded in order to make sure that the part is firmly seated. The block threshold above (BSO) must not be exceeded, as otherwise the workpiece will be damaged.

The block threshold below (BSU) must be reached. This is where blocking force monitoring starts.

The block threshold above (BSO) must not be exceeded, since otherwise manufacturing tolerances will be violated.

ForceMaster 9110

Monitoring parameters for case 2:

In this case there are no force thresholds, since the tool finishes the insertion displacement. The displacement is, however, must be monitored, in order to detect exceeding the manufacturing tolerances.

The block threshold below (BSU) must be reached.

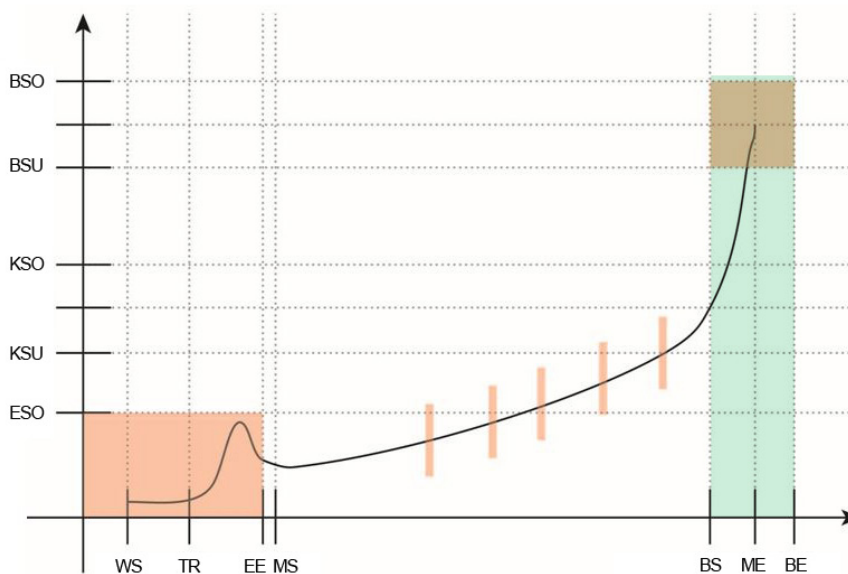

The block threshold above (BSO) must not be exceeded, since otherwise manufacturing tolerances will be violated.



Abbreviations:

WS = displacement start	TR = trigger
MS = measurement start	ME = measurement end
KSU = force threshold below	KSO = force threshold above
BS = block start	BE = block end
BSU = block threshold below	BSO = block threshold above
EE = end thread in	ESO = thread in threshold above

Key:

 Region	 Thread in window	 Block window	 Gateway
--	--	--	---

Region 5

Peening is a special case. A fastening effect is generated in peening operations through the deformation of material. Peening operations usually involve a short displacement. It is useful here to monitor the peening displacement and to check that a minimum peening force is achieved.

A force threshold above must not be exceeded, since otherwise there is a risk that the workpiece may be damaged or destroyed.

The following applies if a peening operation is to be monitored:

Only the peening displacement is monitored. The peening displacement starts when the lower blocking force threshold is exceeded. The displacement value measured at this position is stored (peening start position). The maximum peening displacement is determined like a slave pointer. The relative peening displacement is calculated when the lower blocking force threshold is exceeded. The peening displacement is monitored for two parameters.



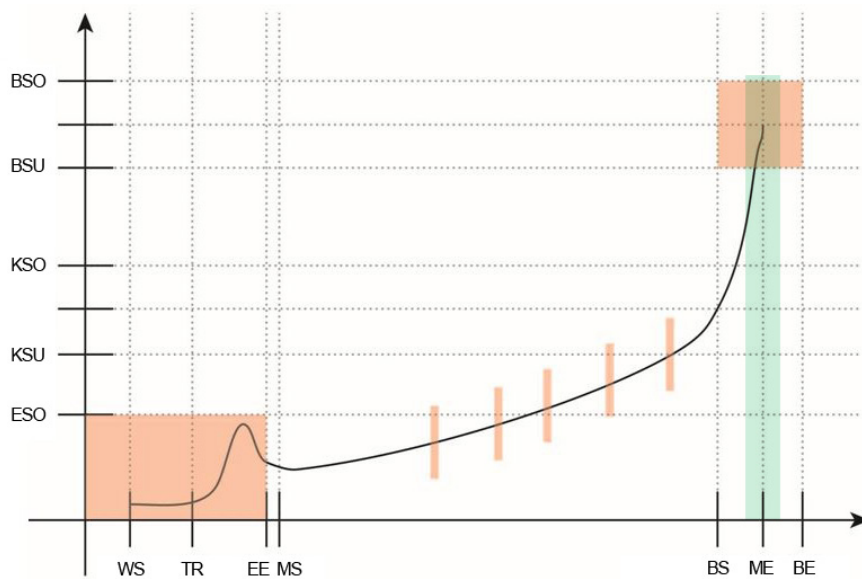

Minimum peening displacement is the displacement that the peening operation must at least have required. Maximum peening displacement is the displacement that must not be exceeded, since otherwise manufacturing tolerances will not be observed.



Abbreviations:

- | | |
|-----------------------------|---------------------------------|
| WS = displacement start | TR = trigger |
| MS = measurement start | ME = measurement end |
| KSU = force threshold below | KSO = force threshold above |
| BS = block start | BE = block end |
| BSU = block threshold below | BSO = block threshold above |
| EE = end thread in | ESO = thread in threshold above |

Key:

- | | | | |
|--|--|--|---|
|  Region |  Thread in window |  Block window |  Gateway |
|--|--|--|---|

Special case: Force monitoring only

If no displacement sensor is attached to ForceMaster 9110, none of the monitoring regions can be used, since the ForceMaster 9110 cannot establish a relationship between force and displacement.

There is only, therefore, a force threshold below (KSU) and a force threshold above (KSO).

8. Technical data

General device data

- Display: 2-line illuminated LCD display
- Warning and acknowledgement tones: adjustable signal type
- Warning tone volume: up to 75 dB
- Measurement channels: Force/displacement or force/time
- Interface: USB, RS232
- Mains connection 90 ... 240 V AC / 50 ... 60 Hz
- Cut-off frequency: 1 kHz
- Working temperature range: 0 ... 60 °C
- Air humidity: 10 ... 80 %, no condensation
- Housing type: Aluminum profile housing
- Protection class: IP20
- Connections: coded special connector
- Sampling interval: 10 kHz
- Number of I/O: 8 input / 8 outputs
- Dimensions (W x H x D): 150 x 95 x 260 [mm]
- Weight: approx. 3 kg

Sensors for the force channel

- Bridge resistor: 350 Ω ... 5 k Ω
- Connecting technology: 4-wire
- Sensor excitation: 5 V
- Excitation current: 20 mA
- Power consumption: approx. 0.3 VA
- Input voltage: 1 mV ... 10 mV
- Deviation: < 1% of full scale

Sensors for the displacement channel

- Sensor type: potentiometric displacement sensor
- Track resistance: 1 k Ω ... 5 k Ω
- Displacement magnitude: 10 mm ... 150 mm
- Deviation: < 1% of full scale

9. Configuration notes

Measurements must be taken to monitor the quality of the pressing processes that are being used more and more often. You have decided to do this with the ForceMaster 9110.

The press has force and displacement sensors mounted on it for this purpose. These sensors supply a measurement signal to the ForceMaster 9110. It evaluates the profile of the force in relation to displacement. If the values exceed or fall below specified limits, the pressing operation is reported as faulty. The correct choice of sensors is very important if this process is to run smoothly.

You therefore need a load cell and the displacement sensor. We have arranged for the installation of the sensors to be as user-friendly as possible. Equipping or retrofitting a press is done quickly. You only need a few minutes to fit a load cell. The displacement sensor can be mounted in no more than 15 minutes. Our technology allows the ForceMaster 9110 to be set up for your particular production process in a very short time.

9.1 Choosing the right load cell

The range of forces appropriate for the sensor to be chosen does not depend on your press, but on your application. If, for example, the pressing force required for your production operation is about 200 N, which will be done on a press that can deliver 5 kN, and you buy a load cell capable of up to 5 kN, it will not supply a useful measurement signal at 200 N, since this is only 4% of the full-scale value of the sensor. For this example, choosing a sensor with a full-scale value of 500 N would be appropriate.

The majority of load cells are damaged if they are loaded with twice their rated value. In the example described, this would appear to happen if we only consider the rated value of the components, the 5 kN of the press and the 500 N of the sensor. The sensor would be overloaded. This applies to the majority of load cells. Our Type 8552 load cells can also withstand this kind of overload.

So do not choose your load cell in the light of the rating of the press, but according to the forces that will occur in your application.

If you don't know the figure, send us your parts, and we will measure the force. Alternatively you can request a trial system from us, with one or more load cells, with which you can carry out test measurements. Once either we or you have found out what the forces that occur are, you can order the correct load cell.

Presses with different receptacle holes for load cells are available on the market. We can offer you sensors for receptacle holes with particular graduations between 10 mm and 16 mm that are suitable for almost any typical commercial press.

9.2 Choosing the right displacement sensor

The stroke of your press is crucial for the choice of displacement sensor. If the press has a stroke and 50 mm, you can get a 50 mm displacement sensor from us.

Note, however, that the smallest resolution step for a 50 mm displacement sensor is 0.0125 mm (measured displacement/4000). It is possible that this resolution is too coarse for your application. In peening operations, the active measuring displacements are often less than 2 mm. This would mean that in this example you would only be able to resolve 160 steps within the active measuring window. For some applications this is inadequate.

A 10 mm sensor would be more suitable for the example above. The resolution step size here is 0.0025 mm. This would make 800 resolution steps available for the peening operation, which is sufficient for a good evaluation. Your displacement sensor should therefore also be chosen in the light of your application.

An adapter set comes with the displacement sensor, with which you can mount it on practically any typical commercial press.

9.3 Advice

If you like, we can also make a suitable choice for you. We need your specifications for this. Contact us, and we will be glad to give you further advice.

10. Available accessories

- 9110-Z001 MasterCard for full configuration access
- 9110-Z002 (PLC card, storage of PLC step chain procedures)
- 9110-Z003 (Tool card for storing the tool data and measuring programs)
- 8552 Load cell
- 5501-Z004 Assembly kit for displacement sensors on manual presses
- 8713 Displacement sensor
- 9900-K349 (USB cable to PC)
- 9900-K333 (RS232 cable to PC)
- 99221-591A-0090030 Connecting cable for potentiometric displacement sensors with plug-in connections
- 9900-V245 Connecting plug for load cells, sensor calibration data stored in the plug
- 9900-V221 Connecting plug for potentiometric displacement sensors, sensor calibration data stored in the plug
- 99005 Connector mounting
- 9110-P001 Configuration and analysis software FMControl

ForceMaster 9110

11. Ordering example

- ForceMaster with PLC function and USB logging, setting up and evaluation software (under preparation) **Type 9110-V0101**

Order code

ForceMaster	9110 V	x	x	x	x
Standard		0	0	0	0
Options	Step chain function		1		
	USB stick logging				1

Accessories

- Assembly kit for easy assembly of the displacement sensor to the manual press **Model 5501-Z004**
- Connecting cable for potentiometric displacement sensors with plug-in connection (e.g. 8712) **Model 99221-591A-0090030**
- RS232 cable to PC **Model 9900-K333**
- USB cable to PC **Model 9900-K349**
- MasterCard** for full configuration access **Model 9110-Z001**
- PLC card** for saving PLC step chain processes on the card **Model 9110-Z002**
- Tool card** for saving the tool data and measuring program **Model 9110-Z003**
- Connecting plug for load cells, sensor calibration data stored in the plug **Model 9900-V245**
- Connecting plug for potentiometric displacement sensors, sensor calibration data stored in the plug **Model 9900-V221**
- Connector mounting **Model 99005**

12. Index

A

Ambient conditions..... 10
 Assembly kit..... 40, 41, 91, 92
 Autoconfig..... 21, 22, 43, 74
 Autoconfiguration..... 12, 21, 26, 39, 44
 Automation..... 13

B

Blocking force 23, 24, 47, 68, 85

C

Cam 31, 32, 33, 60, 61, 62
 Cams 13, 36, 63
 Card reader..... 27
 Commissioning 40
 Conditions of use 10
 Connecting cable 91, 92
 Connecting plug 91, 92
 Connecting technology 88
 Connector pin assignments 37
 Conversions 11
 Counter 12, 32, 49, 61
 Counters 50
 Customer name 56

D

Data storage 52, 56
 Date 56, 79
 Dimensions 88
 Displacement channel..... 88
 Displacement measurement system
 41, 42
 Displacement sensor 39, 41, 42, 74,
 89, 90
 Displacement start 83
 Down counter..... 27, 31, 49, 50, 60

E

Error acknowledgement 37, 39, 46, 68,
 69
 Error message 27, 34, 39, 45, 52
 Error signals..... 68

F

Force alarms 34
 Force channel 88
 Force gateways 84
 Force profile 23
 Force threshold .24, 25, 31, 47, 56, 60,
 83, 84, 86, 87

G

Gateways..... 38, 47, 84
 Grub screw..... 40

H

Housing type 88
 Humidity 10

I

I/O interface..... 37
 Indicator lamp..... 14
 Item designation..... 72
 Item number 71

L

Level 25
 Load cell..... 39, 40, 41, 89
 Loudspeaker 14

M

Mains connection 15, 88
 Mains switch..... 15
 Manual press..... 40, 41, 42, 92
 Manual presses..... 91
 Manual settings 66
 Manufacturing tolerances 85, 87
 Master card 27, 34, 39
 Master carte 48, 68
 MasterCard 27, 34, 39, 48, 68
 Measurement chain..... 43
 Measurement channels 88
 Measuring mode 45
 Modes 20, 21, 22, 43

ForceMaster 9110

O

Operating temperature.....	10
Order data.....	56, 71, 72
Order number.....	27, 56, 71, 72

P

Parts counter.....	50
Parts counters.....	49
Peening displacement...23, 24, 26, 86, 87	
Personnel.....	11
PLC.....	28, 32, 35, 37, 57, 61, 63
PLC card.....	27, 63
PLCCard.....	27, 63
Press.....	34, 36, 41, 46, 49, 74, 82, 85, 89, 90
Press head.....	40, 42
Press plunger.....	36, 40, 42
Pressing curve.....	13
Pressing region.....	22, 84
Pressing tool.....	40, 83
Probe tip.....	41
Profile.....	21, 89
Protection class.....	10, 88

R

Readjustment.....	42
RS232.....	15, 74, 76, 88, 91, 92

S

Scope of supply.....	11
----------------------	----

Sensing pin.....	74, 75
Standard settings.....	75
Statistics.....	73
Status.....	80
Step chain.....	28, 32, 35, 57, 61
Storage conditions.....	10
Supply voltage.....	10
Switching on procedure.....	39

T

Teach-in.....	21, 22, 43
Text and number input.....	20
Thread in force.....	23, 25, 26, 47, 83
Thread in process.....	84
Time.....	56, 79
Tool card.....	27, 63
ToolCard.....	27, 63
Tore.....	84
Trigger point.....	34, 56

U

USB stick.....	12, 51, 52, 71
----------------	----------------

W

Warning.....	9, 68
Warning tone.....	68
Warranty.....	2, 11
Weight.....	88
Working temperature.....	88
Workpiece...21, 34, 36, 74, 82, 84, 85, 86	